

OPERATOR'S AND ORGANIZATIONAL MAINTENANCE MANUAL
FOR
GRENADES

This copy is a reprint which includes current pages from Changes 1 through 12.

WARNING

Handle grenades and components containing explosives with utmost care at all times.
Never disassemble grenades without specific authorization.
Wait 30 minutes before approaching thrown grenade suspected of being dud.
Never make unauthorized modifications to grenades.

CHANGE
NO. 17

HEADQUARTERS
DEPARTMENT OF THE ARMY
Washington, DC, 15 March 2002

**OPERATOR'S AND UNIT
MAINTENANCE MANUAL
FOR
GRENADES**

DISTRIBUTION STATEMENT A: Approved for public release; distribution is unlimited.

TM 9-1330-200-12, dated 17 September 1971, is changed as follows:

1. File this change sheet in front of the publication for reference purposes.
2. Remove old pages and insert new pages as indicated below.
3. New or changed material is indicated by a vertical bar in the margin of the page.
4. Added or revised illustrations are indicated by a vertical bar adjacent to the illustration identification number.

Remove pages

A and B
1-1 thru 1-6
1-9 and 1-10
2-1 and 2-2
A-1 and A-2
C-5 thru C-10

Insert pages

A and B
1-1 thru 1-6
1-9 and 1-10
2-1 and 2-2
A-1 and A-2
C-5 thru C-10

By Order of the Secretary of the Army:

Official:

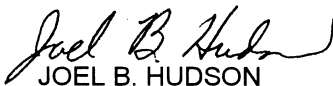
JOEL B. HUDSON
*Administrative Assistant to the
Secretary of the Army*

ERIC K. SHINSEKI
*General, United States Army
Chief of Staff*

0206302

Distribution:

To be distributed in accordance with IDN 400332, requirements for TM 9-1330-200-12.

CHANGE
NO. 16

HEADQUARTERS
DEPARTMENT OF THE ARMY
Washington, DC, 28 December 2001

**OPERATOR'S AND UNIT
MAINTENANCE MANUAL
FOR
GRENADES**

DISTRIBUTION STATEMENT A: Approved for public release; distribution is unlimited.

TM 9-1330-200-12, dated 17 September 1971, is changed as follows:

1. Remove old pages and insert new pages as indicated below.
2. New or changed material is indicated by a vertical bar in the margin of the page.
3. Added or revised illustrations are indicated by a vertical bar adjacent to the illustration identification number.

Remove pages

A and B
i thru iv
1-5 and 1-6
1-10.3 thru 1-10.6
1-11 thru 1-16
2-10.1 and 2-10.2
3-3 thru 3-6
3-11 thru 3-14
A-1 and A-2
C-5 and C-6

Insert pages

A and B
i thru iv
1-5 and 1-6
1-10.3 thru 1-10.6
1-11 thru 1-16
2-10.1 and 2-10.2
3-3 thru 3-6
3-11 thru 3-14
A-1 and A-2
C-5 and C-6

File this change sheet in front of the publication for reference purposes.

By Order of the Secretary of the Army:

Official:

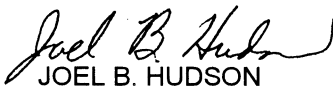
JOEL B. HUDSON
Administrative Assistant to the
Secretary of the Army

ERIC K. SHINSEKI
General, United States Army
Chief of Staff

0134402

Distribution:

To be distributed in accordance with IDN 400332, requirements for TM 9-1330-200-12.

Change)
)
)
 No. 15)

HEADQUARTERS
 DEPARTMENTS OF THE ARMY
 AND THE NAVY
 Washington, DC, 16 June 1995

**OPERATOR'S AND UNIT MAINTENANCE MANUAL
 FOR
 GRENADES**

TM 9-1330-200-12/TM 1330-12/1A, 17 September 1971, is changed as follows:

1. Remove old pages and insert new pages as indicated below. New or changed material is indicated by a vertical bar in the margin of the page. Added or revised illustrations are indicated by a vertical bar adjacent to the identification number.

| <u>Remove pages</u> | <u>Insert pages</u> |
|---------------------|---------------------|
| A and B | A and B |
| 1-5 and 1-6 | 1-5 and 1-6 |
| 1-9 and 1-10 | 1-9 and 1-10 |
| 2-1 and 2-2 | 2-1 and 2-2 |
| 2-11 and 2-12 | 2-11 and 2-12 |
| 3-9 and 3-10 | 3-9 and 3-10 |
| C-3 and C-4 | C-3 and C-4 |
| C-7 and C-8 | C-7 and C-8 |

2. File this change sheet in front of the publication for reference purposes.

By Order of the Secretaries of the Army and the Navy:

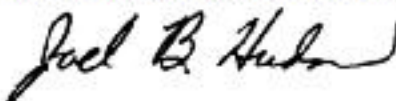
Official: 

JOEL B. HUDSON
*Acting Administrative Assistant to the
 Secretary of the Army*
 00342

GORDON R. SULLIVAN
*General, United States Army
 Chief of Staff*

RONALD D. ELLIOTT
*Executive Director
 Marine Corps Systems Command*

Distribution:

Army:

To be distributed in accordance with DA Form 12-40-E, Block 0332, requirements for TM 9-1330-200-12.

Marine Corps:

MARCORPS CODE: BE plus 7000159(5)
 7000161(2)

CHANGE)
)
)
 NO. 14)

HEADQUARTERS
 DEPARTMENTS OF THE ARMY
 AND THE NAVY
 Washington, DC, 30 September 1994

**OPERATOR'S AND UNIT MAINTENANCE MANUAL
 FOR
 GRENADES**

TM 9-1330-200-12/TM 1330-12/1A, 17 September 1971, is changed as follows:

1. Remove old pages and insert new pages as indicated below. New or changed material is indicated by a vertical bar in the margin of the page. Added or revised illustrations are indicated by a vertical bar adjacent to the identification number.

| <u>Remove pages</u> | <u>Insert pages</u> |
|-----------------------|---------------------|
| A and B | A and B |
| 1-5 and 1-6 | 1-5 and 1-6 |
| 1-10.3 (1-10.4 blank) | 1-10.3 and 1-10.4 |
| 1-11 and 1-12 | 1-11 and 1-12 |
| 3-3 and 3-4 | 3-3 and 3-4 |
| None | 3-4.1 and 3-4.2 |
| 3-11 and 3-12 | 3-11 and 3-12 |

2. File this change sheet in front of the publication for reference purposes.

By Order of the Secretaries of the Army and the Navy:

GORDON R. SULLIVAN
*General, United States Army
 Chief of Staff*

Official:

MILTON H. HAMILTON
*Administrative Assistant to the
 Secretary of the Army
 07488*

RONALD D. ELLIOTT
*Executive Director
 Marine Corps Systems Command*

Distribution:

Army:

To be distributed in accordance with DA Form 12-40-E, Block #0332, requirements for TM 9-1330-200-12.

Marine Corps:

MARCORPS CODE: BE plus 7000159 (5)
 7000161 (2)

CHANGE)
)
)
 NO. 13)

HEADQUARTERS
 DEPARTMENTS OF THE ARMY
 AND THE NAVY
 Washington, DC, 3 December 1993

**OPERATOR'S AND UNIT MAINTENANCE MANUAL
 FOR
 GRENADES**

TM 9-1330-200-12/TM 1330-12/1A, 17 September 1971, is changed as follows:

1. Remove old pages and insert new pages as indicated below. New or changed material is indicated by a vertical bar in the margin of the page. Added or revised illustrations are indicated by a vertical bar adjacent to the identification number.

| <u>Remove pages</u> | <u>Insert pages</u> |
|----------------------------|------------------------|
| A (B blank) 2-1 and 2-2 | A and B 2-1 and 2-2 |

2. File this change sheet in front of the publication for reference purposes.

By Order of the Secretaries of the Army and the Navy:

GORDON R. SULLIVAN
General, United States Army
Chief of Staff

Official:

MILTON H. HAMILTON
Administrative Assistant to the
Secretary of the Army
 05607

RONALD D. ELLIOTT
Executive Director
Marine Corps Systems Command

Distribution:

To be distributed in accordance with DA Form 12-40-E, Block #0332, requirements for TM 9-1330-200-12.

CHANGE)
)
)
 NO. 12)

HEADQUARTERS
 DEPARTMENTS OF THE ARMY
 AND THE NAVY
 Washington, DC, 31 December 1992

**OPERATOR'S AND UNIT MAINTENANCE MANUAL
 FOR
 GRENADES**

TM 9-1330-200-12/TM 1330-12/1A, 17 September 1971, is changed as follows:

1. Remove old pages and insert new pages as indicated below. New or changed material is indicated by a vertical bar in the margin of the page. Added or revised illustrations are indicated by a vertical bar adjacent to the identification number.

| <u>Remove pages</u> | <u>Insert pages</u> |
|-----------------------|-----------------------|
| A (B blank) | A (B blank) |
| i thru iii (iv blank) | i thru iii (iv blank) |
| 1-5 and 1-6 | 1-5 and 1-6 |
| 1-10.3 (1-10.4 blank) | 1-10.3 (1-10.4 blank) |
| 1-11 thru 1-14 | 1-11 thru 1-14 |
| 2-10.1 (2-10.2 blank) | 2-10.1 (2-10.2 blank) |
| 3-3 thru 3-6 | 3-3 thru 3-6 |
| 3-11 and 3-12 | 3-11 and 3-12 |
| C-5 and C-6 | C-5 and C-6 |

2. File this change sheet in front of the publication for reference purposes.

By Order of the Secretaries of the Army and the Navy:

GORDON R. SULLIVAN
General, United States Army
Chief of Staff

Official:

MILTON H. HAMILTON
Administrative Assistant to the
Secretary of the Army
 03366

RONALD D. ELLIOTT
Executive Director
Marine Corps Systems Command

Distribution:

Army:

To be distributed in accordance with DA Form 12-40-E, Block #0332, requirements for TM 9-1330-200-12/TM 1330-12/1A

Marine Corps:

MARCORPS CODE: BE plus 7000159 (5)
7000161 (2)

CHANGE



NO. 11

HEADQUARTERS
DEPARTMENTS OF THE ARMY

Washington, DC, 24 August 1988

**OPERATOR'S AND UNIT MAINTENANCE MANUAL
FOR
GRENADES**

TM 9-1330-200-12/OP 3833. 1st Rev Vol 2/TM 1330-12/1A, 17 September 1971, is changed as follows:

1. Remove old pages and insert new pages as indicated below. New or changed material is indicated by a vertical bar in the margin of the page. Added or revised illustrations are indicated by a vertical bar adjacent to the identification number.

Remove pagesInsert pages

A
i and ii
3-3 and 3-4

A
i and ii
3-3 and 3-4

2. File this change in front of the publication for reference purposes.

By Order of the Secretaries of the Army and the Navy:

CARL E. VUONO
General, United States Army
Chief of Staff

Official

R.L. DILWORTH
Brigadier General, United States Army
The Adjutant General

JOSEPH J. WENT
Lieutenant General, USMC
Deputy Chief of Staff for Installations and Logistics

DISTRIBUTION:

Active Army:

To be distributed in accordance with DA Form 12-40A-R, Operator's and Unit Maintenance Requirements for Grenades.

Marine Corps:

MARCOPRS CODES: BE plus 7000159(5)
7000161(2)

CHANGE)
)
)
NO. 10)

HEADQUARTERS
DEPARTMENTS OF THE ARMY

Washington, DC, 10 November 1986

**OPERATOR'S AND UNIT MAINTENANCE MANUAL
FOR
GRENADES**

TM 9-1330-200-12/TM 1330-12/1A, 17 September 1971, is changed as follows:

1. Remove old pages and insert new pages as indicated below. New or changed material is indicated by a vertical bar in the margin of the page. Added or revised illustrations are indicated by a vertical bar adjacent to the identification number.

| Remove pages | Insert pages |
|-----------------------|-----------------------------|
| None | A page |
| i thru iii (iv blank) | i thru iii (iv blank) |
| 1-5 and 1-6 | 1-5 and 1-6 |
| None | 1-10.1 and 1-10.2 |
| 1-11 and 1-12 | 1-11 thru 1-13 (1-14 blank) |
| 2-1 and 2-2 | 2-1 and 2-2 |
| 2-10.1 (2-10.2 blank) | 2-10.1 (2-10.2 blank) |
| 3-1 thru 3-6 | 3-1 thru 3-6 |
| None | 3-6.1 (3-6.2 blank) |
| 3-11 and 3-12 | 3-11 and 3-12 |
| C-5 and C-6 | C-5 and C-6 |

2. File this change in front of the publication for reference purposes.

By Order of the Secretaries of the Army and the Navy:

JOHN A. WICKHAM, JR.
General, United States Army
Chief of Staff

Official
R. L. DILWORTH
Brigadier General, United States Army
The Adjutant General

GEORGE B. CRIST
Lieutenant General, USMC
Deputy Chief of Staff for Installations and Logistics

DISTRIBUTION:

Active Army:

To be distributed in accordance with DA Form 12-40-R, Operators and Organizational Maintenance Requirements for Grenades.

Marine Corps:

MARCORPS CODES: BE plus 7000159(5)
7000161(2)

INSERT LATEST CHANGED PAGES. DESTROY SUPERSEDED PAGES

LIST OF EFFECTIVE PAGES

NOTE The portion of the text affected by the changes is indicated by a vertical line in the margin of the page. Changes to illustrations are indicated by a vertical line adjacent to the identification number.

Dates of issue for original and changed pages are:

| | |
|--|---|
| Original..... 0..... 17 September 1971 | Change 9 16 August 1984 |
| Change 1..... 20 February 1976 | Change 10 29 August 1986 |
| Change 2..... 18 March 1976 | Change 11 24 August 1988 |
| Change 3..... 11 March 1977 | Change 12 31 December 1992 |
| Change 4..... 23 May 1978 | Change 13 3 December 1993 |
| Change 5..... 30 May 1979 | Change 14 30 September 1994 |
| Change 6..... 31 March 1980 | Change 15 16 June 1995 |
| Change 7..... 25 January 1982 | Change 16 28 December 2001 |
| Change 8..... 20 December 1982 | Change 17 15 March 2002 |

TOTAL NUMBER OF PAGES IN THIS PUBLICATION IS 93, CONSISTING OF THE FOLLOWING:

| Page No. | *Change No. | Page No. | *Change No. |
|--------------------|-------------|-----------------|-------------|
| Cover | 0 | 3-1 and 3-2 | 10 |
| A | 17 | 3-3 | 16 |
| B | 13 | 3-4 | 14 |
| i thru iv | 16 | 3-4.1 and 3-4.2 | 14 |
| 1-1 thru 1-4 | 17 | 3-5 | 12 |
| 1-5 | 16 | 3-6 | 16 |
| 1-6 | 17 | 3-6.1 | 10 |
| 1-7 | 7 | 3-6.2 blank | 10 |
| 1-8 | 4 | 3-7 and 3-8 | 2 |
| 1-9 | 17 | 3-8.1 | 2 |
| 1-10 | 8 | 3-8.2 | 0 |
| 1-10.1 and 1-10.2 | 10 | 3-9 | 0 |
| 1-10.3 thru 1-10.6 | 16 | 3-10 | 15 |
| 1-11 | 14 | 3-11 thru 3-14 | 16 |
| 1-12 thru 1-16 | 16 | 4-1 thru 4-3 | 0 |
| 2-1 and 2-2 | 17 | 4-4 blank | 0 |
| 2-2.1 thru 2-2.5 | 8 | 5-1 and 5-2 | 0 |
| 2-2.6 blank | 0 | A-1 and A-2 | 17 |
| 2-3 and 2-4 | 0 | B-1 and B-2 | 5 |
| 2-5 and 2-6 | 3 | C-1 thru C-3 | 0 |
| 2-7 thru 2-10 | 0 | C-4 | 15 |
| 2-10.1 and 2-10.2 | 16 | C-5 thru C-10 | 17 |
| 2-11 | 15 | | |
| 2-12 thru 2-15 | 0 | | |
| 2-16 | 0 | | |

*Zero in this column indicates an original page

THIS PAGE INTENTIONALLY LEFT BLANK

TECHNICAL MANUAL)
 No. 9-1330-200-12/)
 TM 1330-12/1A)

DEPARTMENTS OF THE ARMY
 AND THE NAVY
 Washington, DC, 17 September 1971

**OPERATOR'S AND
 UNIT MAINTENANCE MANUAL
 FOR
 GRENADES**

REPORTING ERRORS AND RECOMMENDING IMPROVEMENTS

You can help improve this manual. If you find any mistakes or if you know of a way to improve the procedures, please let us know. You may mail, e-mail, or FAX your response. Mail your letter, DA Form 2028 (Recommended Changes to Publications and Blank Forms), or DA Form 2028-2 located in the back of this manual direct to: Commander, U.S. Army TACOM, Armament Research, Development and Engineering Center, ATTN: AMSTA-AR-WEL-S, Picatinny Arsenal, NJ 07806-5000. E-mail address is LSB@PICA.ARMY.MIL. FAX number is Commercial (973) 724-4633, DSN 880-4633. A reply will be furnished to you.

| | | <u>Page</u> |
|--------------|--|-------------|
| CHAPTER 1. | INTRODUCTION | |
| Section I. | General | |
| | Scope | 1-1 |
| | Forms, records and reports | 1-1 |
| Section II. | Description and Functioning | |
| | General | 1-2 |
| | Hand grenades | 1-2 |
| | Rifle grenades | 1-2 |
| | Grenade, Launcher, Smoke: Screening, RP, UK L8A1, UK L8A3 | 1-11 |
| | Grenade, Launcher, Smoke: IR Screening, M76 | 1-11 |
| | Grenade, Launcher, Smoke: Simulant Screening, M82 | 1-11 |
| | Grenade, Launcher, Smoke: Screening, TA, M90 | 1-12 |
| | Grenade, Discharger: Anti-Riot, Irritant, CS, L96A1 | 1-12 |
| | Grenade, Discharger: Anti-Riot, Practice, L97A1 | 1-12 |
| Section III. | Safety, Care, and Handling | |
| | Safety | 1-12 |
| | Care | 1-13 |
| | Handling | 1-13 |
| CHAPTER 2. | OPERATING INSTRUCTIONS | |
| Section I. | Operating Under Usual Conditions | |
| | Hand grenades | 2-1 |
| | Rifle grenades | 2-6 |
| | Launcher grenades | 2-10.1 |
| Section II. | Operation of Materiel Used in Conjunction with Major Items | |
| | Grenade projection adapters | 2-11 |
| | Rifle grenade cartridges | 2-13 |
| Section III. | Operation Under Unusual Conditions | |
| | General | 2-15 |
| | Extreme temperature conditions | 2-15 |

*This manual supersedes TM 9-1330-200-12/TM 1330-12/1, 18 June 1969, including all changes; and together with TM 9-1330-200-34, 1 December 1971, and TM 43-0001-29, 31 October 1977, supersedes TM 9-1330-200, 17 September 1971, including all changes.

| | | |
|--------------|--|-------|
| CHAPTER 3. | MAINTENANCE INSTRUCTIONS | |
| Section I. | Service Upon Receipt of Materiel | |
| 3-1. | General..... | 3-1 |
| 3-2. | Precautions..... | 3-1 |
| 3-3. | Unpacking..... | 3-1 |
| Section II. | Tools and Equipment | |
| 3-4. | Common tools and equipment..... | 3-4 |
| 3-5. | Special tools and equipment..... | 3-4 |
| Section III. | Maintenance User-Operator | |
| 3-6. | General..... | 3-4.1 |
| 3-7. | Inspection..... | 3-4.1 |
| 3-8. | Cleaning/preservation..... | 3-6 |
| Section IV. | Maintenance-Organizational | |
| 3-9. | General..... | 3-10 |
| 3-10. | Unpacking..... | 3-10 |
| 3-11. | Inspection..... | 3-10 |
| 3-12. | Touch-up and spot painting..... | 3-10 |
| 3-13. | Repacking..... | 3-11 |
| 3-14. | Repacking L8A1 grenades, L8A3 grenades..... | 3-12 |
| 3-15. | Repacking M90 grenades..... | 3-12 |
| 3-16. | Repacking L96A1 and L97A1 grenades..... | 3-13 |
| CHAPTER 4. | SHIPMENT AND STORAGE | |
| Section I. | Shipment | |
| 4-1. | Precautions..... | 4-1 |
| 4-2. | Instructions..... | 4-1 |
| 4-3. | Data..... | 4-1 |
| Section II. | Storage | |
| 4-4. | Precautions..... | 4-1 |
| 4-5. | Data..... | 4-1 |
| 4-6. | Procedures..... | 4-3 |
| CHAPTER 5. | DESTRUCTION OF GRENADES TO PREVENT ENEMY USE | |
| 5-1. | General..... | 5-1 |
| 5-2. | Methods..... | 5-1 |
| APPENDIX A. | REFERENCES..... | A-1 |
| APPENDIX B. | MAINTENANCE SUPPLIES..... | B-1 |
| APPENDIX C. | MAINTENANCE ALLOCATION CHART (MAC)..... | C-1 |

LIST OF ILLUSTRATIONS

| <u>Figure No.</u> | <u>Title</u> | <u>Page</u> |
|-------------------|---|-------------|
| 1-1 | Representative types of hand grenades..... | 1-6 |
| 1-2 | CS riot hand grenade M47..... | 1-7 |
| 1-3 | Pushing safety latch to armed position (A, righthanded thrower; B, lefthanded thrower)..... | 1-8 |
| 1-4 | Representative types of rifle grenades..... | 1-9 |
| 1-5 | Grenade, Launcher, Smoke: Screening, RP UK L8A1..... | 1-10 |
| 1-5a | Grenade, Launcher, Smoke: Screening, RP UK L8A3..... | 1-10.1 |
| 1-5b | Grenade, Launcher, Smoke: IR Screening, M76..... | 1-10.2 |
| 1-5c | Grenade, Launcher, Smoke: Simulant Screening, M82..... | 1-10.3 |
| 1-5d | Grenade, Launcher, Smoke: Screening TA, M90..... | 1-10.4 |
| 1-5e | Grenade, Discharger: Anti-Riot, Irritant, CS, L96A1..... | 1-10.5 |
| 1-5f | Grenade, Discharger: Anti-Riot, Practice, L97A1..... | 1-10.6 |
| 1-6 | Ammunition pouch..... | 1-13 |
| 2-0 | Inspection of grenades..... | 2-2.1 |

| <u>Figure No.</u> | <u>Title</u> | <u>Page</u> |
|-------------------|---|-------------|
| 2-0.1 | Hand grenade packed upside down (fuze down) | 2-2.2 |
| 2-0.2 | Hand grenade packed right side up (fuze up) without safety pin and pull ring | 2-2.2 |
| 2-1 | Grenade with damaged safety lever and broken fuze lugs | 2-2.3 |
| 2-1.1 | Criteria for hinge ear engagement (tips past center line and turned up) | 2-2.4 |
| 2-1.2 | Fuze safety hinge ear repair | 2-2.5 |
| 2-2 | Screwing practice grenade body onto fuze | 2-3 |
| 2-3 | Assembly of safety clip to grenade M69 | 2-4 |
| 2-4 | Assembly of safety clip to grenade M62 | 2-5 |
| 2-5 | Insertion of practice charge and plastic stopper | 2-7 |
| 2-6 | Assembly of safety clip to fuzes M206 series | 2-8 |
| 2-7 | Screwing offensive grenade body onto fuze | 2-9 |
| 2-8 | Replacement of safety wire and safety clip | 2-10 |
| 2-9 | Grenade projection adapter M1A2 | 2-12 |
| 2-10 | Grenade projection adapter M2A1 | 2-14 |
| 2-11 | Representative rifle grenade cartridges | 2-15 |
| 3-1 | Deleted | 3-2 |
| 3-2 | Deleted | 3-2 |
| 3-3 | Deleted | 3-2 |
| 3-3.1 | M76 Smoke grenade ammunition box | 3-3 |
| 3-3.2 | IR and Simulant grenade boxes and packing | 3-4 |
| 3-4 | Adjustment of safety pin | 3-5 |
| 3-5 | Assembly of safety clip to grenade M67 | 3-6.1 |
| 3-6 | Fuze seated w/safety clips | 3-7 |
| 3-6.1 | Tightening fuze to insure correct seating | 3-8 |
| 3-7 | Acceptable and dented nose protection caps | 3-8.1 |
| 3-8 | Defective stabilizer tube and fin assembly | 3-9 |
| 3-9 | Cleaning grenades | 3-9 |
| 3-10 | Replacement of cover and taping in place | 3-11 |
| 3-11 | Typical outer packing and markings | 3-11 |
| 3-11.1 | Grenade/spacer assembly | 3-12 |
| 3-11.2 | M90 Grenade/repackaging instructions | 3-14 |
| 4-1 | Damaged packing box | 4-1 |

THIS PAGE INTENTIONALLY LEFT BLANK

CHAPTER 1

INTRODUCTION

Section 1. GENERAL

1-1 Scope

Information in this manual is limited to responsibilities of operator and organizational support maintenance personnel (i.e., maintenance not beyond the scope of the tools, equipment or supplies normally available to operator and organizational personnel). Specifically, this manual contains instructions for operation; inspection; storage; packaging; and basic maintenance. The prescribed maintenance responsibilities of the direct and general support level apply as reflected in the maintenance allocation chart (MAC) in Appendix B of this manual.

1-2. Forms, Records and Reports

a. *General.* Responsibility for execution of forms, records and reports rests upon the officers of all units maintaining subject material. However, the value of accurate documents must be appreciated by all persons responsible for data compilation, maintenance and use. Records, reports and authorized forms normally indicate the type, quantity and condition of materiel to be inspected, to be repaired or to be used in repair. Properly executed forms convey authorization and serve as records for repair or replacement of materiel requiring further repair. Overall forms, records and reports establish work required, progress of the work within the shops and status of the materiel upon completion of its repair.

b. *Authorized Forms.* The forms generally applicable to units maintaining subject materiel are listed in appendix A. For a current listing of all forms, refer to DA Pam 25-30. Refer to DA Pam 738-750 for instructions on use and completion of all forms required for operating and maintaining hand grenades and rifle grenades.

c. *Field Report of Accidents.* Accidents involving injury to personnel or damage to materiel will be reported on DA Form 285 (Accident Report) in accordance with AR 385-40. Marine Corps units will report accidents in accordance with MCO 5101.8.

d. *Malfunctions Involving Ammunition or Explosives.*

(1) A malfunction is defined as the failure of a grenade to function in accordance with the expected performance when fired, launched, or

when explosive components function during a non-functional test. A critical malfunction is one which may cause a hazard in the circumstances described above. For purposes of clarity, malfunctions do not include accidents and incidents resulting from negligence, malpractice, or implication in other situations such as vehicle accidents, fires, etc. However, malfunctions do include abnormal or premature function of explosive ammunition items during normal handling, maintenance, storage, transportation, and tactical deployment.

(2) If a malfunction involving this materiel occurs, *firing of the affected lot will be halted immediately.* The commanding officer or senior individual in charge of the unit will immediately contact the officer under whose supervision the ammunition for the unit involved is maintained or issued and will report all available facts concerning the malfunction.

(3) Ammunition malfunction reports from Army activities will be reported as prescribed in AR 75-1.

(4) Ammunition malfunction reports from Marine Corps activities will be reported as prescribed in MCO 8025.1.

e. *Report of Damaged or Improper Shipment.* All shipments of these munitions received in damaged or otherwise unsatisfactory condition because of deficiencies in preservation, packaging, marking, loading, storage, or handling will be reported on SF 364 (Report of Discrepancy (ROD) in accordance with AR 735-11-2. Reports of damaged or improper shipment due to transportation discrepancies are to be reported on SF 361 in accordance with AR 55-38. Marine Corps units will submit such reports in accordance with MCO 4610.5 and Military Traffic Management Regulations (NAVMC 1175).

f. *Equipment Improvement Recommendations.* Put it on an SF 368 (Product Quality Deficiency Report). Mail it to: U.S. Army TACOM/ARDEC, ATTN: AMSTA-AR-QAW-C, Rock Island, IL 61299-7630. We will send you a reply.

Section II. DESCRIPTION AND FUNCTIONING

1-3. General

Grenades are small bombs of a size and shape convenient for throwing by hand or launching from a rifle or vehicle. The hand grenade is thrown by hand. However, some hand grenades may be launched from a rifle grenade projection adapter and by a special grenade cartridge. The rifle grenade is launched by a special grenade cartridge from a rifle. Hand grenades are used to supplement small arms against an enemy in close combat, for producing a riot control agent, for smoke screening and signaling, and for incendiary purposes. Rifle grenades are used against armored targets, fortifications and personnel, and for screening and signaling. Tables 1-1 and 1-2 contain a listing of authorized hand and rifle grenades, respectively. Table 1-3 lists special type grenades. Table 1-4 lists time to grenade functioning after release of safety lever.

1-4. Hand Grenades

a. *General.* All Army hand grenades have pyrotechnic delay fuzes except for Grenades M68, M59 (M33 with Fuze, M217) (M33A1), M57 and M26A2 which are assembled with an impact-delay-type fuze. A grenade assembled with a pyrotechnic delay fuze will not function by impact action. A grenade assembled with an impact-delay-type fuze will function on impact action after an arming time of 1.6 seconds. If the grenade fails to function on impact, the secondary pyrotechnic delay feature of the fuze will function the grenade within 3 to 7 seconds.

b. *Types.* There are six types of hand grenades (fig. 1-1):

(1) *Fragmentation hand grenades.* These grenades are used to produce casualties by high velocity projection of fragment.

(2) *Illuminating hand grenade.* This grenade is used to provide illumination of terrain and targets.

(3) *Chemical hand grenades.* These grenades are used for incendiary, screening, signaling, training or riot control purposes.

(4) *Offensive hand grenade.* This grenade is used for blast effect.

(5) *Practice and training hand grenades.* These grenades are for training personnel in use, care and handling of service grenades. Model designations of the grenades are indicated in table 1-4.

(6) *Non-lethal hand grenade.* This grenade is used for diversionary purposes.

c. *Functioning.*

(1) *General.* Release of the safety clip and removal of the safety pin permit release of the safety lever. When the grenade is thrown, the safety lever is released and is forced away from the grenade body by a striker acting under the force of a striker spring. The striker rotates on its axis, and then strikes the percussion primer, initiating the fuze. The grenade then functions within the time shown in table 1-4.

(2) *Grenades M47 (fig. 1-2) and M48.* Grenade fuze M227 is restrained from functioning by the safety cotter pin, sliding safety latch, and handle. The exhaust port seal is removed and discarded immediately before pulling the safety cotter pin. When the safety cotter pin is removed and the safety latch is pushed rearward (fig. 1-3) from the lock pin, the handle is unlocked and the GRENADE IS ARMED. Releasing the handle causes the arming pin spring to eject the arming pin. This releases the firing pin, allowing the firing pin to activate the primer. The primer ignites the first-fire mixture, which flashes and ignites the delay mixture. This, in turn, ignites the ignition mixture. The ignition mixture burns through an aluminum foil shield on the bottom of the fuze and ignites the granulated CS pyrotechnic mixture in the grenade body. The burning mixture builds up pressure and opens the tape covering the exhaust port. This pressure also forces release of CS from the grenade, while jet action causes the grenade to move quickly and erratically along the ground. The M48 functions in the same manner as the M47, except that the M48 emits red smoke.

1-5. Rifle Grenades

a. *General.* Rifle grenades (fig. 1-4) are fin-stabilized. They are launched from a rifle. The propelling force for the grenade is provided by a special gas-producing grenade cartridge, which is loaded into the rifle chamber. Rifle grenades

Table 1: Authorized Hand Grenades

| Description | Model Designation | DODAC | Color Coding | Use | Fuze Model Designation | Issue with Safety Clip |
|-----------------------|--------------------------------|--|--|---|------------------------|---|
| Fragmentation, delay | M67 | 1330-G881 | Olive drab w/yellow markings | Produces casualties by high-velocity of fragments | M213 | Required |
| Fragmentation, delay | M33 | 1330-G888 | Olive drab w/yellow markings | Produces casualties by high-velocity of fragments | M213 | Not required |
| Fragmentation, delay | M61 | 1330-G880 | Olive drab w/yellow markings | Produces casualties by high-velocity of fragments | M204A1 M204A2 | Required |
| Fragmentation, delay | M26A1 | 1330-G890 | Olive drab w/yellow markings | Produces casualties by high-velocity of fragments | M204A1 M204A2 | Not required |
| Fragmentation, delay | M26 | 1330-G890 | Olive drab w/yellow markings | Produces casualties by high-velocity of fragments | M204A1 M204A2 | Not required |
| Fragmentation, delay | Mk2 | 1330-G890 | Olive drab w/yellow band around fuze well | Produces casualties by high-velocity of fragments | M204A1 M204A2 | Not required |
| Fragmentation, impact | M68 | 1330-G802 | Olive drab w/yellow markings | Produces casualties by high-velocity of fragments | M217 | Required |
| Fragmentation, impact | M59 (M33 w/Fuze, M217) (M33A1) | 1330-G887 | Olive drab w/yellow markings | Produces casualties by high-velocity of fragments | M217 | Not required |
| Fragmentation, impact | M57 | 1330-G896 | Olive drab w/yellow marking | Produces casualties by high-velocity of fragments | M217 | Required |
| Fragmentation, impact | M26A2 | 1330-G889 | Olive drab w/yellow markings | Produces casualties by high-velocity of fragments | M217 | Not required |
| Offensive | Mk3A2 | 1330-G911 w/Fuze 1330-G910 w/o Fuze | Black w/yellow markings | Blast effect or demolition | M206A2 | With or without safety clip |
| Illuminating | Mk1 | 1330-G895 | All white or unpainted w/white band w/black markings | Illumination and signalling incendiary purposes against flammable targets | Integral | Not required |
| Non-Lethal (Stun) | M84 | 1330-GG09 | Olive drab w/white markings w/pastel green band on body and brown band on safety lever | Diversiary purposes | Integral P/N 1750-037 | Primary safety pin with round pull ring; secondary safety pin with triangular pull ring |

Change 17 1-3

TM 9-1330-200-12/TM 1330-12/1A

Table 1: Authorized Hand Grenades - Continued

| Description | Model Designation | DODAC | Color Coding | Use | Fuze Model Designation | Issue with Safety Clip |
|--|------------------------|--|---|---|------------------------|------------------------|
| Riot, CN | M7, M7A1 | 1330-G960 | Gray w/1 red band and red markings | Control riots, mobs, and other disturbances | M201A1 | Not required |
| Riot, CS | ABC-M7A2 ABC-M7A3 | 1330-G963 | Gray w/red band and red markings | Control riots, mobs, and other disturbances | M201A1 | Not required |
| Riot, CS | M47 | 1330-G922 | Gray w/red band black markings | Control riots, mobs, and other disturbances | M227 | Not required |
| Smoke, HC | AN-M8 | 1330-G930 | Light green w/black markings | Generate white smoke for signalling and screening | M201A1 | Not required |
| Riot, Pocket CS | M58 | 1330-G933 | Gray w/red band and red markings | Simulate casualty agents during training | M201A1E1 | Not required |
| Riot, CS1 | ABC-M25A2 | 1330-G928 | Gray w/red band and red markings | Simulate casualty agents during training | Integral | Not required |
| Riot, CN1 | ABC-M25A1 ABC-M25A2 | 1330-G927 | Gray w/red band and red markings | Simulate casualty agents during training | Integral | Not required |
| 8 to 12 Second Delay CS | M54 | 1330-G923 | Gray w/red band and red markings | Simulate casualty agents during training | M226 | Not required |
| Smoke, WP Hand-Rifle | M34 | 1330-G937 | Light green w/1 yellow band, light red markings | Signalling, screening, and incendiary purposes | M206A2 | Required |
| Smoke, WP | M15 | 1330-G935 | Gray w/1 yellow band and yellow markings | Signalling, screening, and incendiary purposes | M206A1 M206A2 | Not required |
| Smoke, colored (red, green, yellow, or violet) | M18 | 1330-G950 (red) 1330-G940 (green) 1330-G945 (yellow) 1330-G955 (violet) | Light green w/black markings | Ground to air or ground to ground signalling | M201A1 | Not required |
| Smoke, red, RS | M48 | 1330-G932 | Light green w/black markings | Training | M227 | Not required |
| Incendiary, TH3 | AN-M14 | 1330-G900 | Light red w/black markings | Provides a source for intense heat to destroy equipment | M201A1 | Not required |

Table 1-1. Authorized Hand Grenades - Continued.

| Grenade | Model Designation | DODAC | Color coding | Use | Fuze model designation | Issue with safety clip |
|-----------------|-------------------|-----------|---|----------|------------------------|------------------------|
| Practice, delay | M69 | 1330-G918 | Blue w/brown band w/ white or no markings | Training | M228 | Required |
| Practice, delay | M62 | 1330-G914 | Blue w/brown band w/ white or no markings | Training | M205A1 M205A2 | Required |
| Practice, delay | M30 | 1330-G915 | Blue w/brown band w/ white or no markings | Training | M205A1 M205A2 | Not required |

Table 1-2. Authorized Rifle Grenades.

| Description | Model Designation | DODAC | Color coding | Use | Fuze model designation |
|--------------------------------------|-------------------|--|--|---|------------------------|
| HEAT | M31 | 1330-G970 | Olive drab w/yellow marking | Penetrating effect against targets | M211 |
| Smoke, WP | M19A1 | 1330-H030 | Light green w/yellow band, red marking | Signaling, screening, ignites from mobile targets | Integral |
| Smoke (red, green, violet or yellow) | M22 or M22A2 | 1330-H010 (red) 1330-G095 (green) 1330-H020 (violet) 1330-H035 (yellow) | Light green w/color of smoke produced painted on body union; black marking | Signaling and for laying screen | Integral |

Table 1-3. Special Type Grenades.

| Description | Model Designation | DODAC | Color coding | Use | Fuze model designation |
|---|------------------------|-----------|--|---|------------------------------|
| Launcher, Smoke Screening | RP, UK L8A1 or UK L8A3 | 1330-G970 | Light green base w/ brown band painted on base; brown marking | To provide a self-screening smoke capability for combat vehicles | Integral (f92 electric fuze) |
| Grenade, Launcher Smoke: IR Screening | M76 | 1330-H030 | Light green base w/1 yellow band; black marking | To provide a self-screening infrared smoke capability for combat vehicles | NA |
| Grenade, Launcher Smoke: Simulant Screening) | M82 | 1330-G978 | Light green base w/1 yellow and 2 blue bands; black marking | To provide a training self-screening capability for combat vehicles | NA |
| Grenade, Hand: Smoke, TA, Practice | M83 | TBD | Forest green w/light green marking and blue band | Practice | M201A1 |
| Grenade, Launcher, Smoke: Screening, TA | M90 | GG03 | Top-half black and bottom-half green w/light brown band and black markings | To provide a self-screening smoke capability (visual through near IR wave length) for light vehicles in combat. | NA |
| Grenade, Discharger: Anti-Riot, Irritant, CS, L96A1 | L96A1 | 1330-FZ16 | Gray body w/1 red and 1 brown | To help control rioting crowds by dispersing CS agent | NA |
| Grenade, Discharger: Anti-Riot, Practice, L97A1 | L97A1 | 1330-FZ15 | Blue body w/1 green and 1 brown band | The Anti-riot practice grenade is training grenade for the L96A1 | NA |

may be used against armored targets, against personnel, for screening or signaling, or for incendiary effect against flammable targets. Rifle grenades may be fired at low angles (direct fire) or high angles (indirect fire), depending on the type of grenade being fired and effect desired

b. *Types.* There are three types of rifle grenades currently available:

(1) *Antitank (AT) rifle grenades.* These grenades are used against armored targets or fortifications. The grenade contains a shaped charge capable of penetrating up to 10 inches of armor plate or 20 inches of reinforced concrete at an effective range of 115 meters.

(2) *Chemical rifle grenades.* These grenades are used primarily for screening or signaling purposes. In addition, the WP grenade can also be used for incendiary effect against flammable targets or to inflict injury. Chemical rifle grenades function either upon impact with targets to produce clouds of smoke, or upon projection to produce a long train of smoke through the air.

(3) *Practice rifle grenades.* These grenades are used for training personnel in care, handling and use of service rifle grenades.

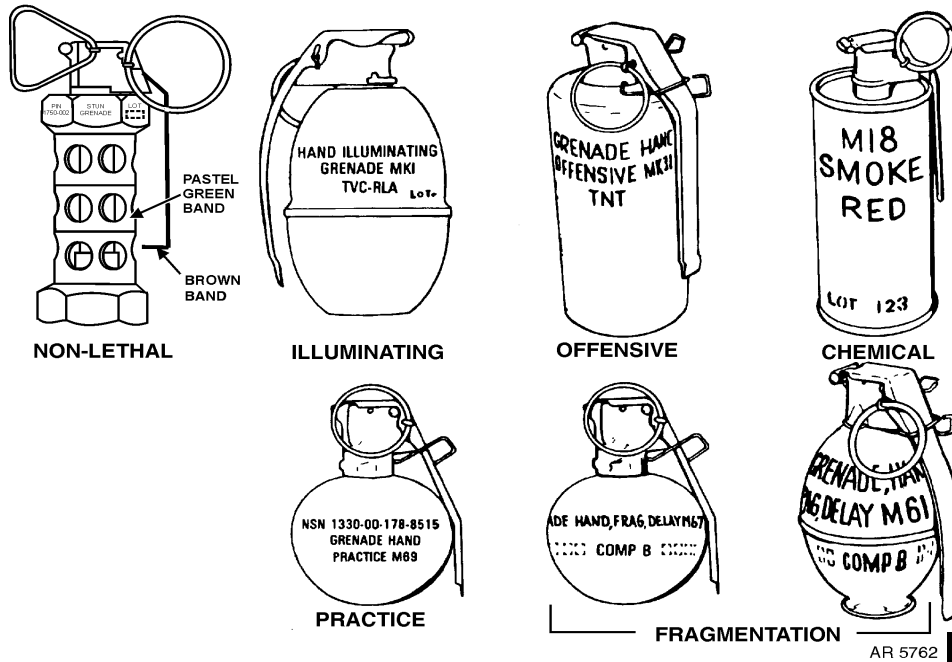
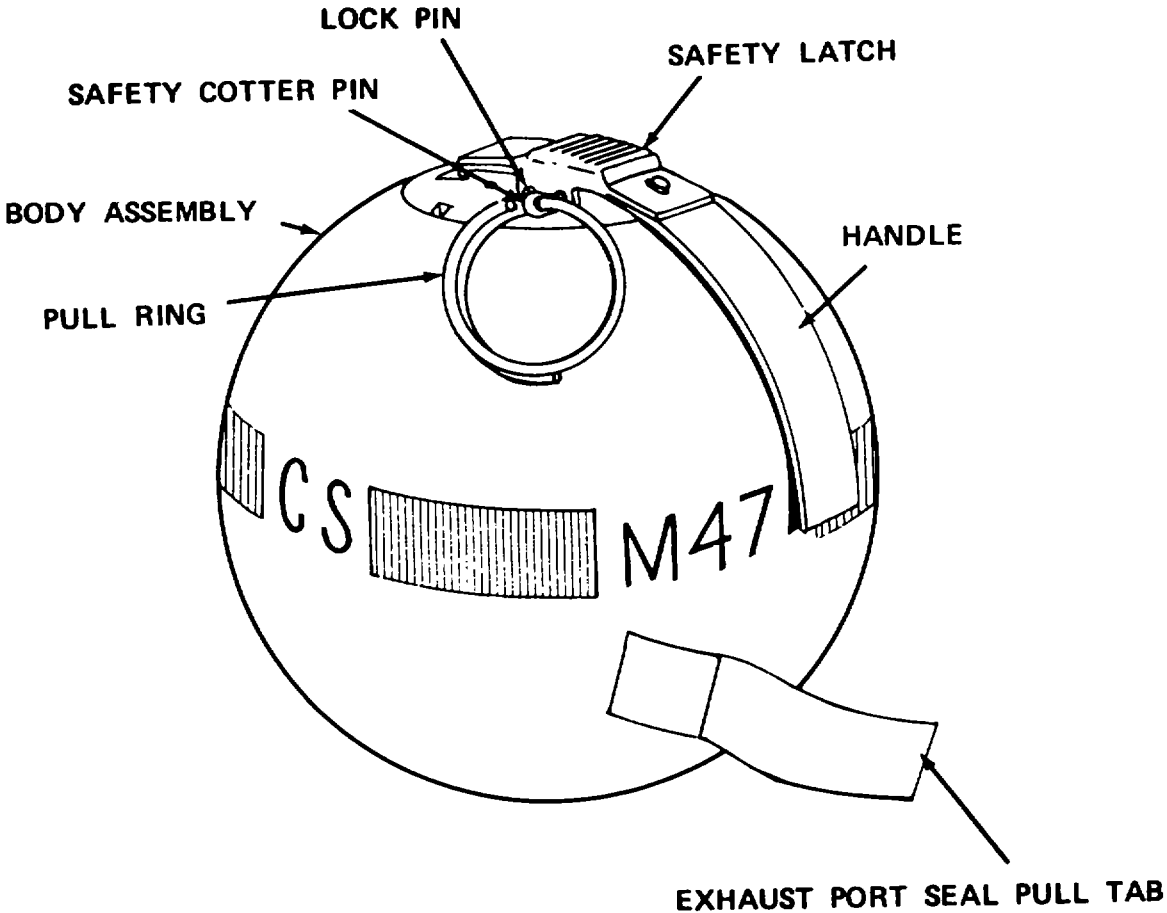

Figure 1-1. Representative types of hand grenades.



ARD81-0096

Figure 1-2. CS riot hand grenade M47.
Change 7 1-7

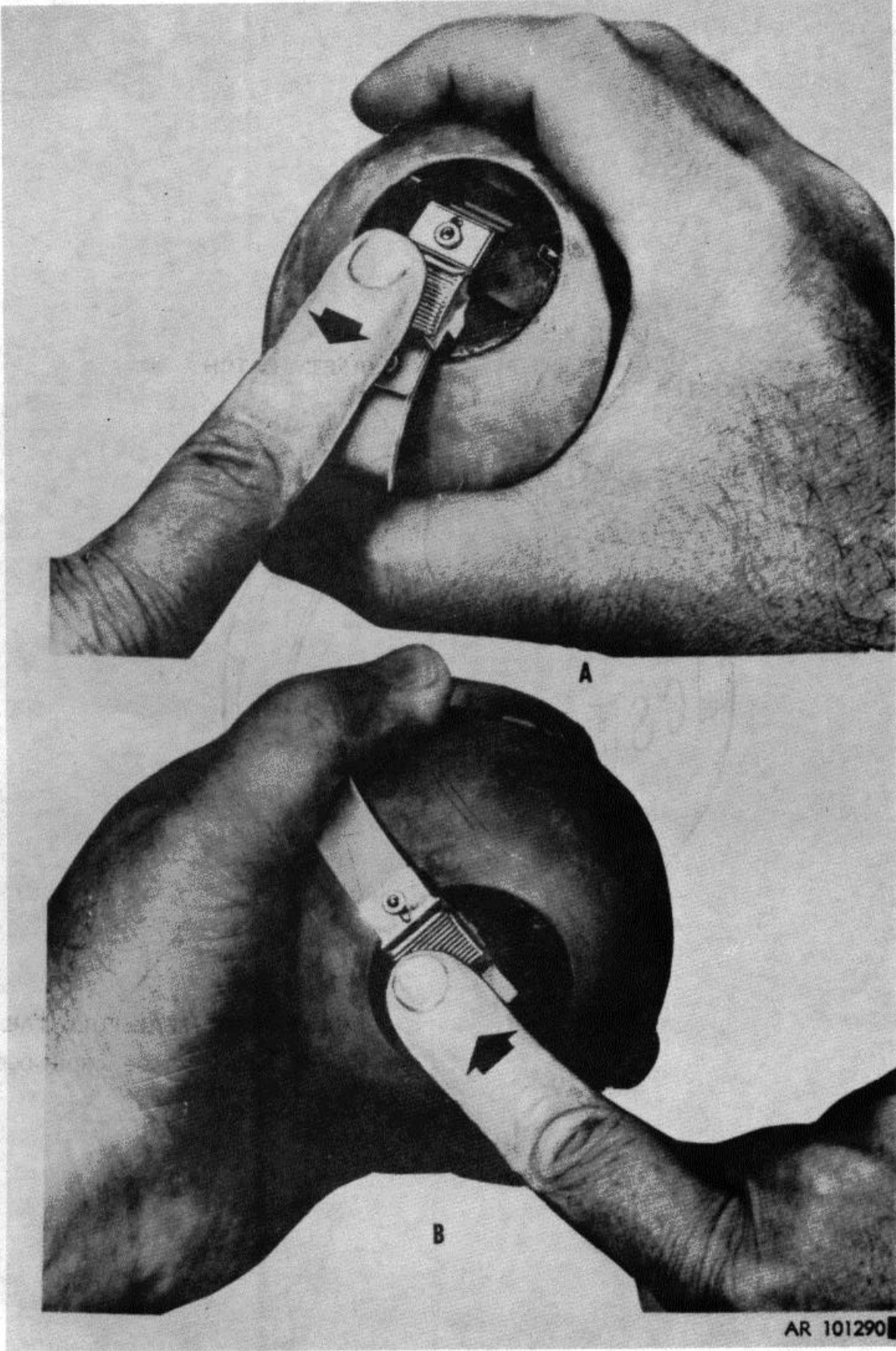

Figure 1-3. Pushing safety latch to armed position (A, righthanded thrower; B, left-handed thrower).
Change 4 1-8

Table 1-4 Time to Grenade Functioning After Release of Safety Lever

| Grenade | | |
|--|---|----------------|
| Type | Model(s) | Time (seconds) |
| <i>High explosives:</i> Fragmentation | M67, M33, M61, M26A1, M26, Mk2 | 4 - 5 |
| | M68, M59, (M33 w/Fuze, M217), (M33A1), M57, M26A2 | Impact or 3-7 |
| Offensive | Mk3A2 | 4 - 5 |
| Illuminating | Mk1 | 7 |
| <i>Chemical:</i> Smoke Smoke, HC, TA and Colored Smoke, RS Riot, CN Riot, CS CS CN1 Riot, CS1 CS | M34, M15 | 4 - 5 |
| | AN-M8, M18, M83 | 0.7-2 |
| | M48 | 5-25 |
| | M7, M7A1 | 0.7-2 |
| | M58, M7A2, M7A3 | |
| | M47 | 5-25 |
| | ABC-M25A1, ABC-M25A2 | 1.4-3 |
| | ABC-M25A2 | |
| M54 | 8-12 | |
| Incendiary | AN-M14 | 0.7-2 |
| <i>Practice:</i> for HE Riot, Simulant | M69, M62, M30 | 4 - 5 |
| | M25A2 | 1.4-3 |
| <i>Non-Lethal:</i> Stun | M84 | 1.0 - 2.3 |

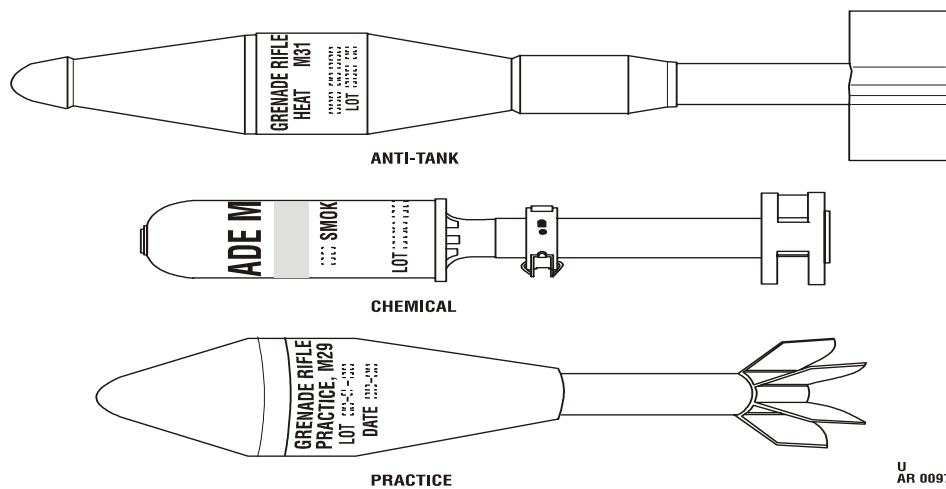

Figure 1-4. Representative types of rifle grenades.

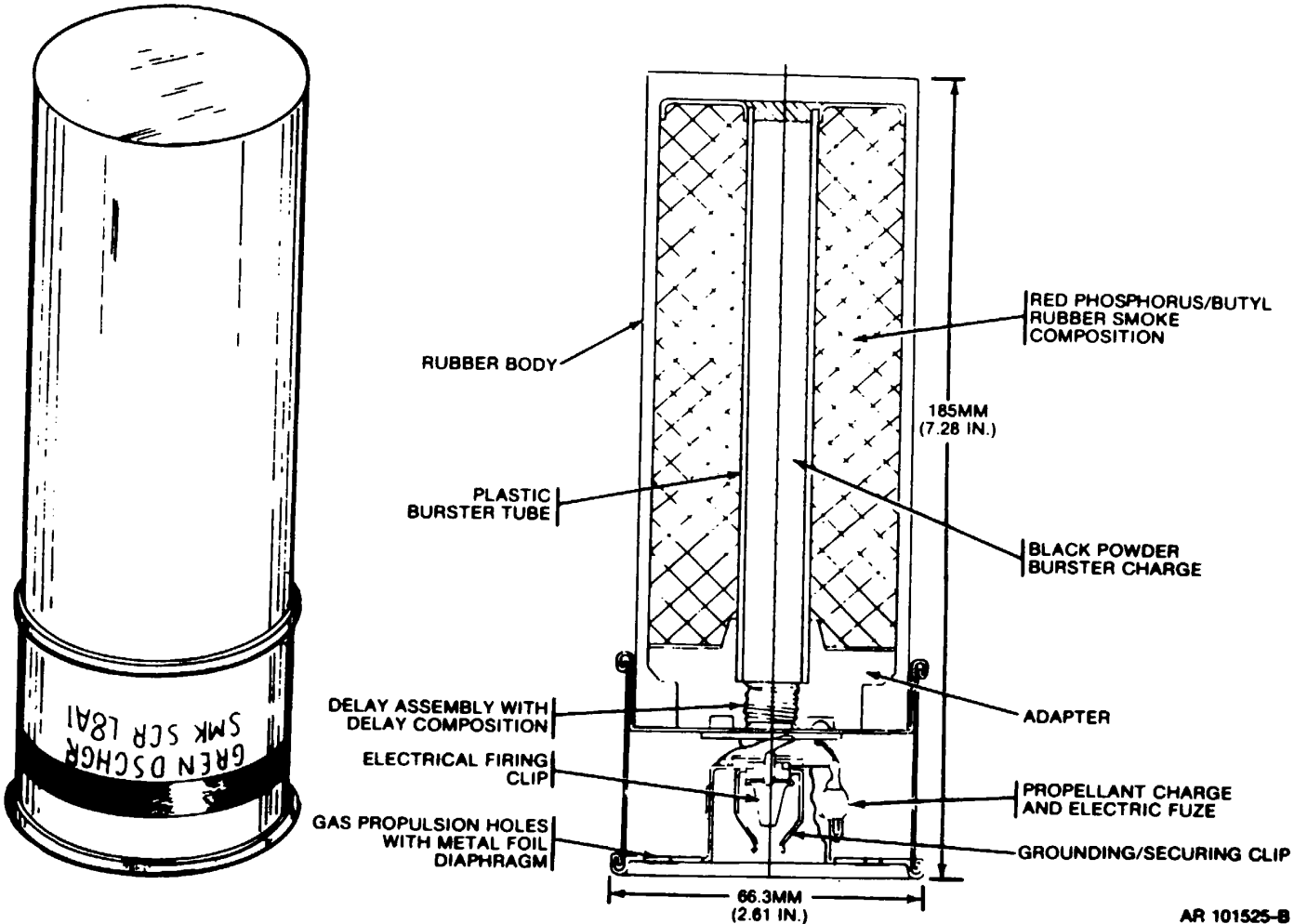

Figure 1-5. Grenade, Launcher, Smoke: Screening, RP, UK, L8A1
Change 8 1-10

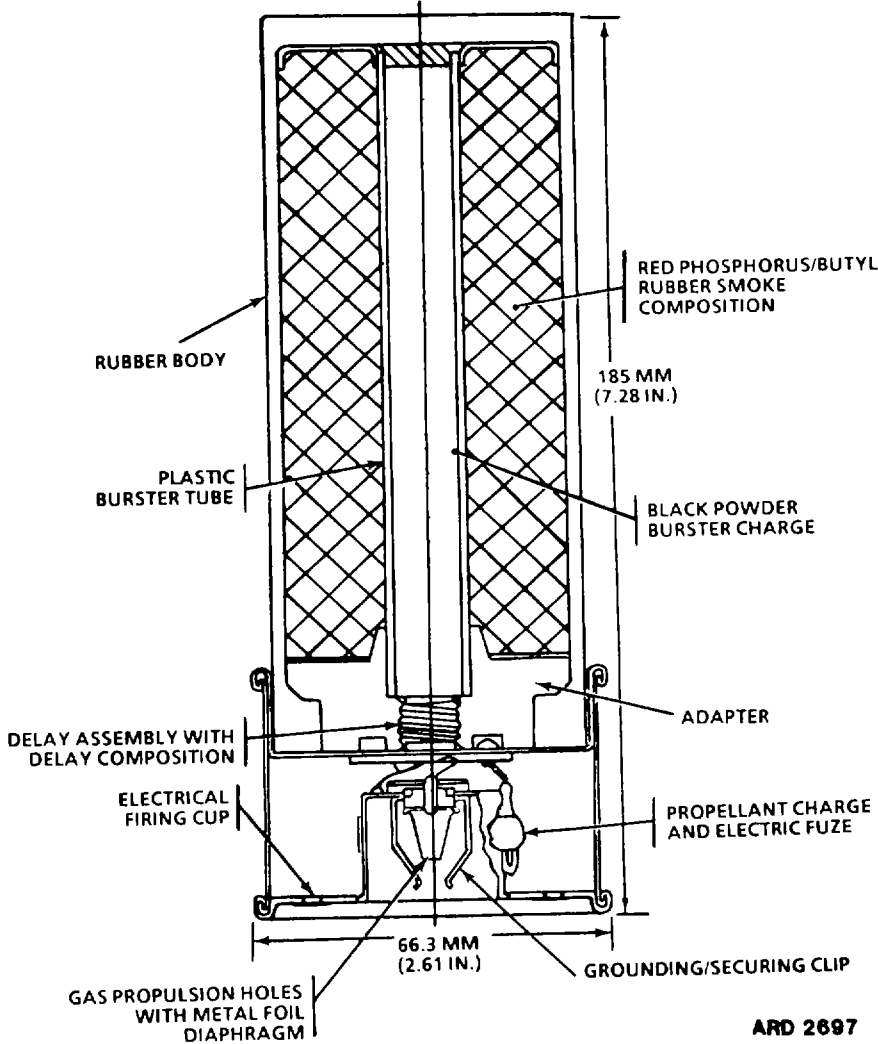
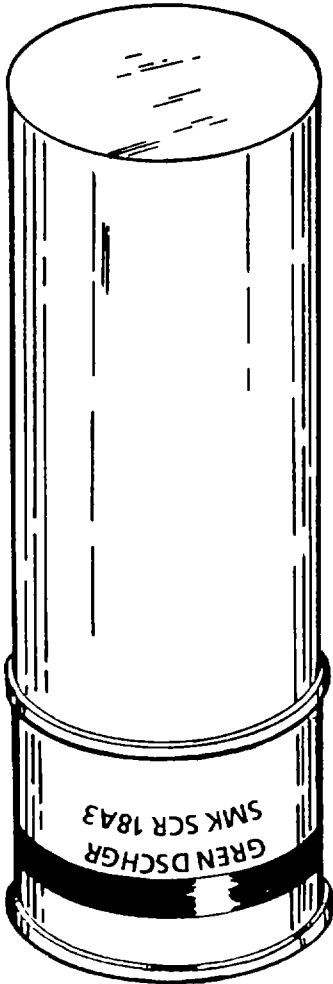
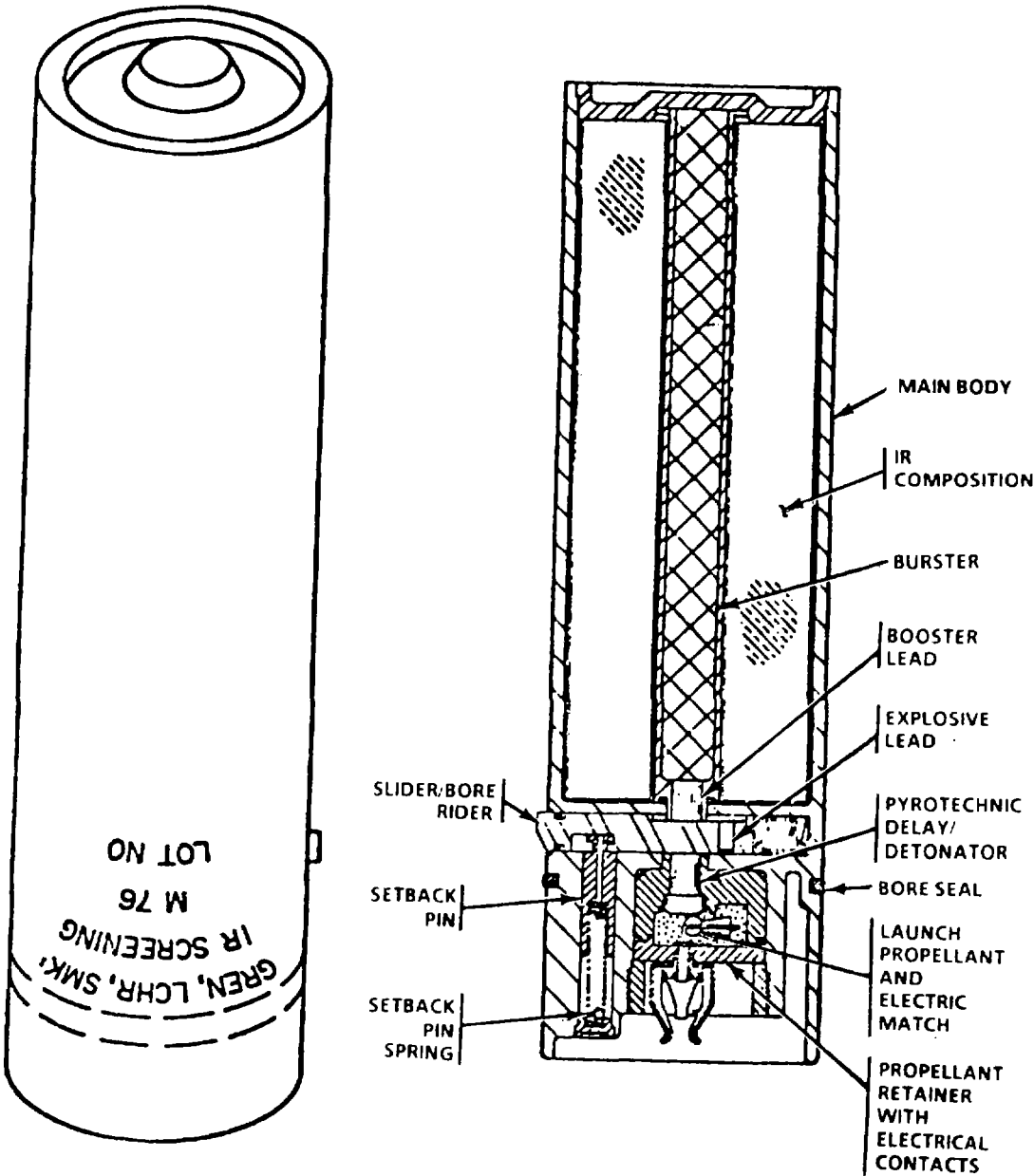
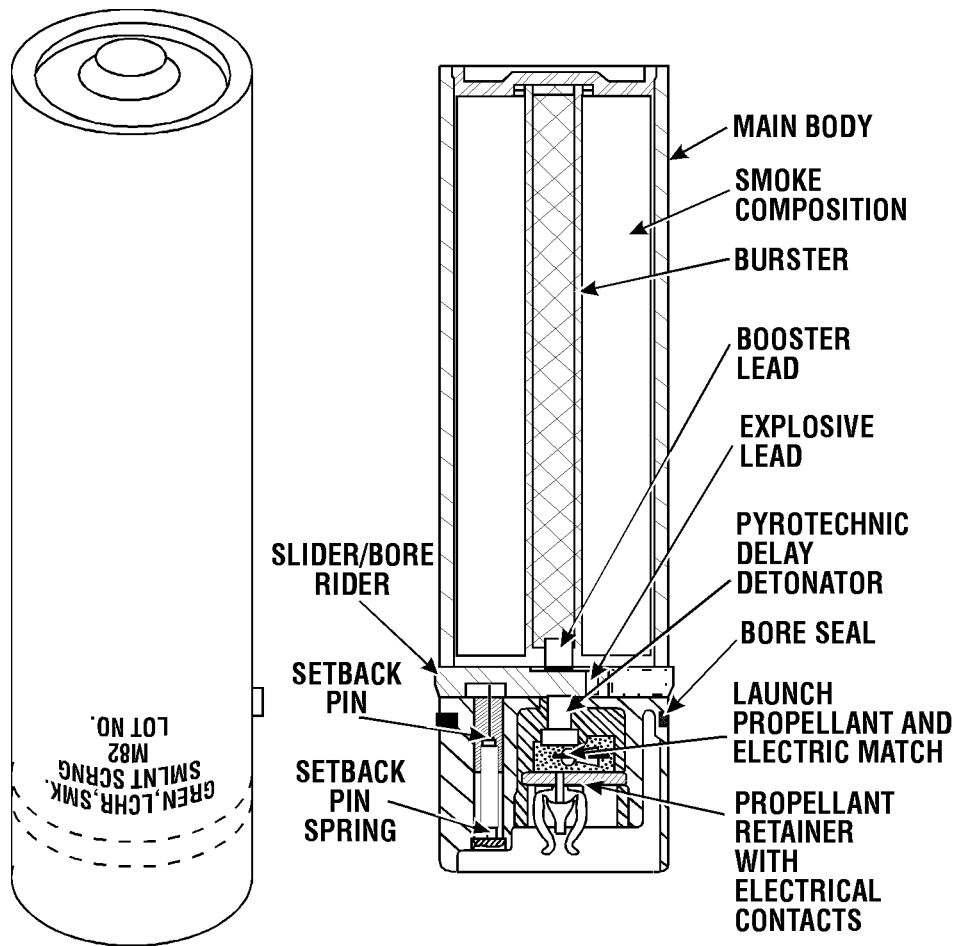

Figure 1-5a. Grenade, Launcher, Smoke: Screening, RP, UK L8A3
Change 10 1-10.1



ARD 2609 ■

Figure 1-5b. Grenade, Launcher, Smoke, IR Screening, M76.
Change 10 1-10.2



U
AR 5761-A

Figure 1-5c. Grenade, Launcher, Smoke: Simulant Screening, M82

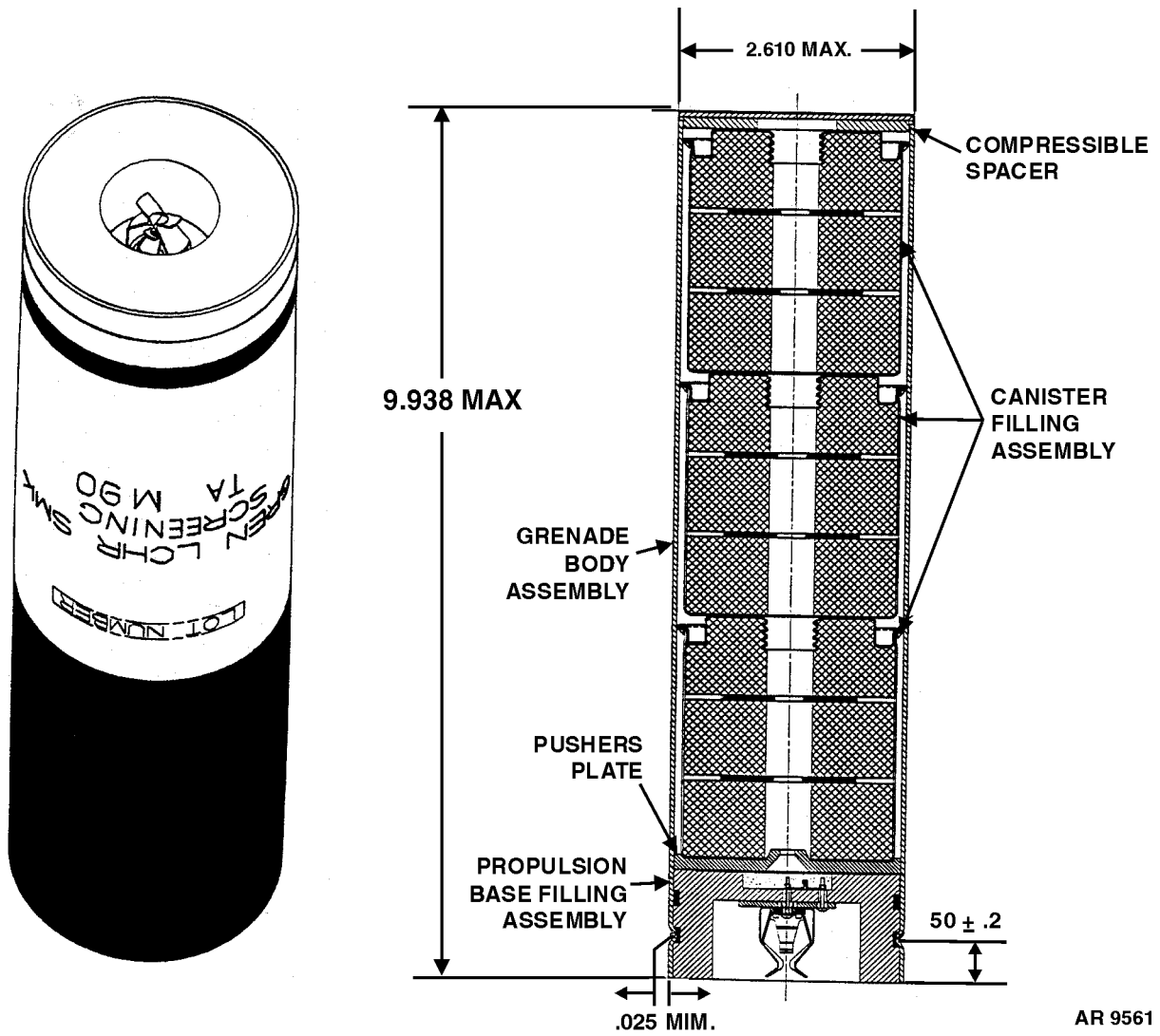

AR 9561

Figure 1-5d. Grenade, Launcher, Smoke: Screening TA, M90

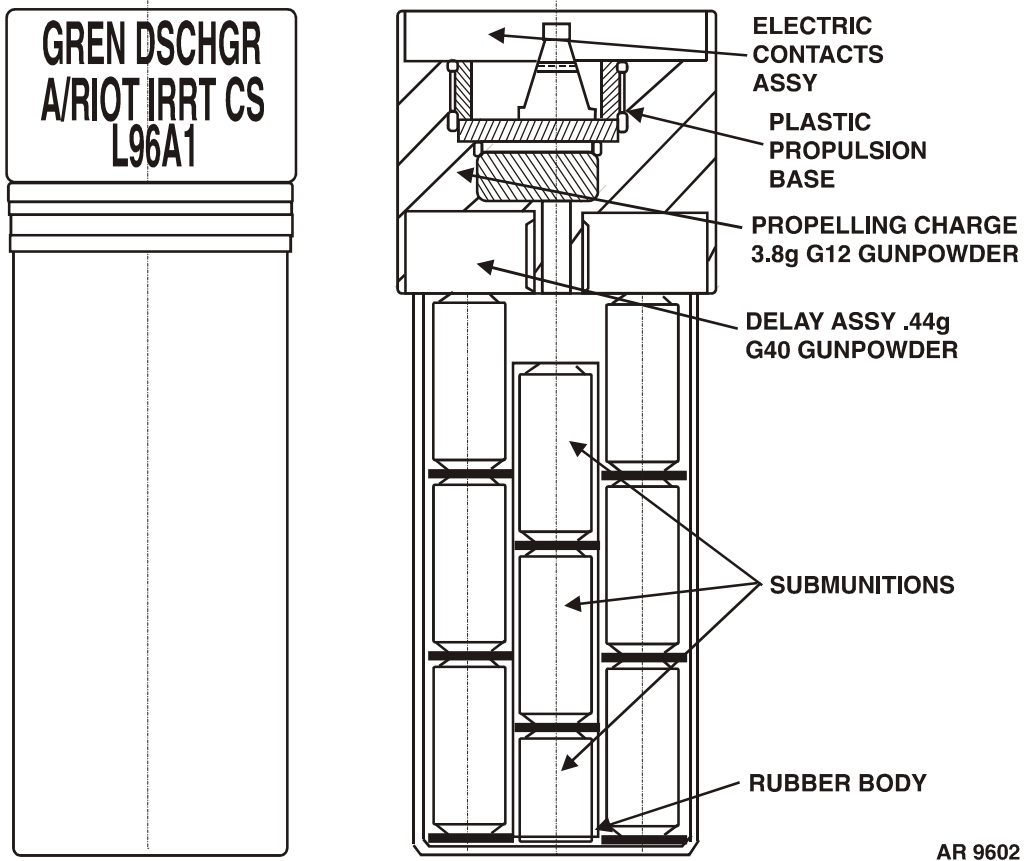

Figure 1-5e. Grenade, Discharger, Anti-Riot, Irritant, CS, L96A1

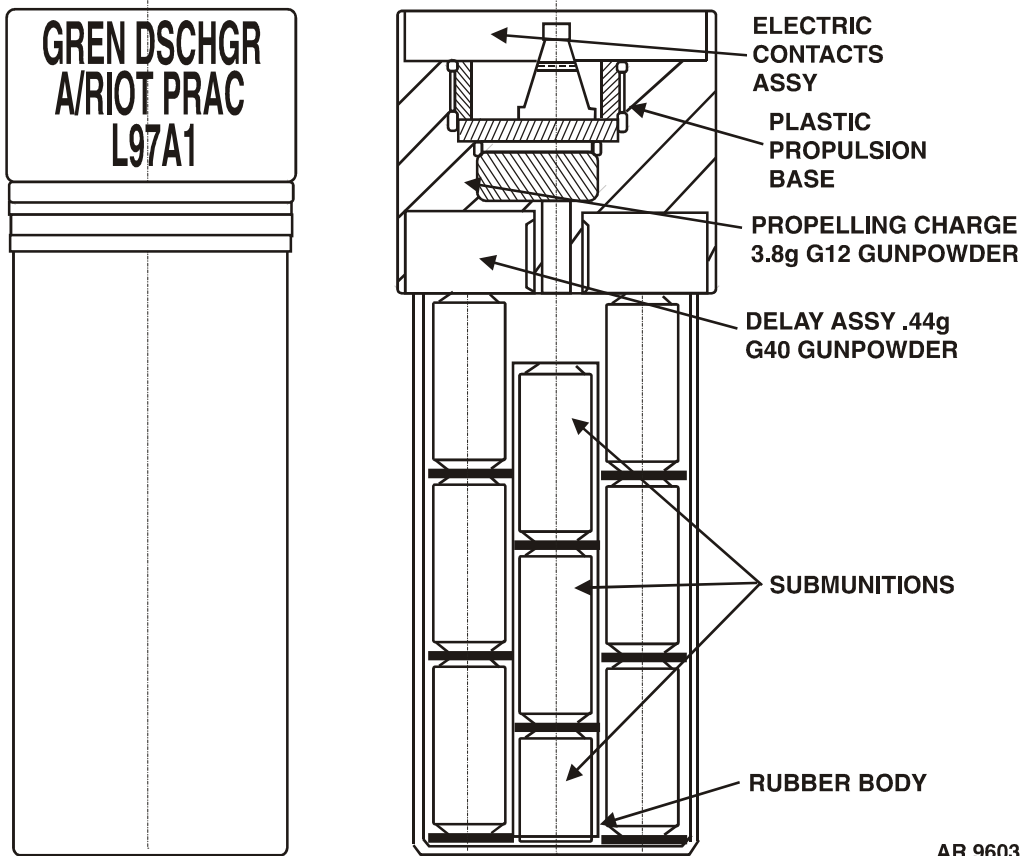

Figure 1-5f. Grenade, Discharger, Anti-Riot, Practice, L97A1

1-6. Grenade, Launcher, Smoke: Screening, RP, UK, L8A1, L8A3

a. General. Provides a self-screening smoke capability for armored tactical vehicles.

(1) Screen vehicles from enemy direct fire weapons when immediate counter-engagement cannot be accomplished.

(2) Conceal vehicles caught out in the open which cannot rapidly find a defilade position.

(3) Screen vehicles caught out in the open during retrograde.

(4) Extricate the crew from a disabled vehicle.

b. Description. The L8A1 grenade (fig. 1-5) and the L8A3 grenade (fig. 1-5a) are used with M239 and similar grenade launchers. The grenades are filled with a red phosphorus/butyl rubber mix. Each grenade is approximately 2-5/8 inches in diameter, 7-9/32 inches long, and weighs approximately 1-1/2 pounds.

c. Functioning. The L8A1 and L8A3 grenades are propelled from the launching device when electrical current at the firing clip activates the electrical squib-type fuze which ignites the propellant charge. Pressure builds up in the metal base, escapes through the propulsion holes, ignites the delay composition, and propels the grenade from the launching device. During flight of the grenade, the delay composition burns for 3/4 of a second for the L8A1 and 1 second for the L8A3 grenade, and ignites the burster charge. The burster charge ignites the red phosphorus/butyl rubber smoke composition and ruptures the rubber grenade body. The ignited smoke composition disperses to produce a white smoke cloud within two seconds after firing at approximately 98 feet (30m) from the launching device. When functioned, the L8A3 grenade generates a smoke cloud faster and more dense than the L8A1. The smoke cloud lasts for more than 2 minutes for both the L8A1 and L8A3 grenades.

1-6.1. Grenade, Launcher, Smoke: IR Screening, M76

a. General. Provides a self-screening infrared smoke capability for armored tactical vehicles.

(1) Screen vehicles from enemy direct fire weapons when immediate counter-engagement cannot be accomplished.

(2) conceal vehicles caught out in the open which cannot rapidly find a defilade position.

(3) Screen vehicles caught in the open during retrograde.

(4) Extricate the crew from a disabled vehicle.

b. Description. The M76 grenade (fig. 15b) is used with M250 and similar grenade launchers. Each grenade is 2.59 inches in diameter, 9.3 inches long, and weighs approximately 4 pounds.

c. Functioning. The M76 grenade is propelled from the launching device (discharger) when electric current at the firing contact activates the electrical match. The electrical match ignites the propellant which launches the grenade and ignites the pyrotechnic time delay. Launch acceleration causes the setback lock to displace aft, out-of-engagement with safe and arm slider. When the slider/bore rider clears the launch tube, it moves into the armed position which aligns the explosive lead with the delay detonator and the booster lead. When the grenade reaches the desired range, the delay detonator ignites the explosive train which detonates the central burster. The IR composition is scattered which creates the brown obscuring cloud.

1-6.2. Grenade, Launcher, Smoke: Simulant Screening, M82

a. General. Provides a self-screening training capability for armored tactical vehicles.

(1) Screen vehicles from enemy direct fire weapons when immediate counter-engagement cannot be accomplished.

(2) Conceal the vehicles caught out in the open which cannot rapidly find a defilade position.

(3) Screen vehicles caught in the open during retrograde.

(4) Extricate the crew from a disabled vehicle.

b. Description. The M82 grenade (fig. 1-5c) is used with M250 and similar grenade launchers. Each grenade is 2.6 inches in diameter, 9.3 inches long, and weighs approximately 3.1 pounds.

c. Functioning. The M82 grenade is propelled from the launching device (discharger) when electric current at the firing contact activates the electrical match. The electrical match

1-6.3. Grenade, Launcher, Smoke: Screening, TA, M90

a. *General.* Provides a self-screening through near infrared wavelength smoke capabilities for light tactical vehicles.

b. *Description.* The M90 grenade is used primarily with the M7 66mm grenade discharger, but is also capable of being fired from the M250, M257, and M6 grenade dischargers. Each grenade is 9.87 inches long, 2.6 inches in diameter and weighs approximately 2.86 pounds.

c. *Functioning.* The M90 grenade contains three individual smoke canisters that are ejected out of the grenade body when electric current is applied to the firing contacts, activating the electric match. The electric match ignites the propellant which burns to create pressure and hot gases inside the grenade body. This ignites the three individual canisters and propels them out of the grenade body a distance of 35 meters. A salvo of four grenades will produce a 30-meter x 2-meter high white smoke screen within six seconds after launch, screening a stationary vehicle approximately 20 seconds depending on weather conditions.

1-6.4. Grenade, Discharger: Anti-Riot, Irritant, CS, L96A1

a. *General.* Provides standoff delivery of irritants from light tactical vehicles for riot/crowd control and protection of convoys in peacekeeping operations.

b. *Description.* The L96A1 is used primarily with the M7 Discharger, which is a component of the Light Vehicle Obscuration Smoke System (LVOSS), and similar 66-0mm grenade dischargers. Each grenade is 2.6 inches in diameter, 7.28 inches long and weighs approximately 1.25 pounds.

c. *Functioning.* The female connector of the propulsion base makes an electrical connection with the firing circuit when pushed onto the male electrical connector at the base of the discharger tube. When the launch system is armed and the firing button is pushed, the firing circuit directs electrical energy from the vehicle's battery to the electric match, which is housed inside the propulsion base. The hot gases emitted from the ignition of the gun powder/black powder ignite the igniter cord and cambric inside the rubber payload via the delay detonator.

1-6.4. Grenade, Discharger: Anti-Riot, Practice, L97A1

a. *General.* The Anti-riot practice grenade will be used as the training grenade for the L96A1.

b. *Description.* The L96A1 is used primarily with the M7 Discharger, which is a component of the Light Vehicle Obscuration Smoke System (LVOSS), and similar 66-0mm grenade dischargers. Each grenade is 2.6 inches in diameter, 7.28 inches long and weighs approximately 1.25 pounds.

c. *Functioning.* The female connector of the propulsion base makes an electrical connection with the firing circuit when pushed onto the male electrical connector at the base of the discharger tube. When the launch system is armed and the firing button is pushed, the firing circuit directs electrical energy from the vehicle's battery to the electric match, which is housed inside the propulsion base. The hot gases emitted from the ignition of the gun powder/black powder ignite the igniter cord and cambric inside the rubber payload via the delay detonator.

Section III. SAFETY, CARE AND HANDLING

1-7. Safety

WARNING

TO PRECLUDE SAFETY HAZARD, NEVER MAKE UNAUTHORIZED MODIFICATIONS TO GRENADES.

- a. Observe precautions generally applicable to use of ammunition. Do not open grenade containers or remove protective safety devices until just before use.
- b. Return all grenades prepared for firing but not fired to their original packing, and mark them appropriately.
- c. When working with WP items, the following precautions apply:

WARNING

WP SMOKE IS POISONOUS UPON PROLONGED OR REPEATED INHALATION, PARTICULARLY IN CONFINED SPACE. NORMAL CONCENTRATIONS IN OPEN AIR ARE NOT LIKELY TO BE HARMFUL.

- (1) Familiarize personnel with first aid procedures for WP burns. Wet particles of WP with water or 5 percent copper sulfate solution; remove particles from flesh immediately.

WARNING

DO NOT WASH EYES WITH 5 PER-CENT COPPER SULFATE SOLUTION. WASH EYES IMMEDIATELY WITH A PREPARED SOLUTION OF 1 PER-CENT COPPER SULFATE. IF THIS SOLUTION IS NOT AVAILABLE, WASH EYES WITH LARGE QUANTITIES OF WATER FOR AT LEAST 15 MINUTES. IN ANY EVENT, SEEK MEDICAL ATTENTION.

- (2) Do not use grease or ointments on WP burns. (Such use may result in poisoning.) Wash affected area with soda solution, then with 5 percent copper sulfate solution.

- d. When exposed to red phosphorus (RP) or hexachloroethane (HC) smoke or any riot control agent, the following precaution applies:

WARNING

RP SMOKE, HC SMOKE, OR ANY RIOT CONTROL AGENT MAY PRESENT AN INHALATION AND IRRITANT HAZARD. PROLONGED EXPOSURE OF THE EYES AND RESPIRATORY SYSTEM SHOULD BE AVOIDED. WEAR PROTECTIVE MASKS TO AVOID EXCESSIVE EXPOSURE.

THE M47/XM47E3 AND M48/XM48E3 HAND GRENADES PRESENT A RISK OF SERIOUS EYE INJURY IF THEY FUNCTION IN THE HANGFIRE (DELAY) MODE. A LONG-TERM HANGFIRE (DELAY) IS POSSIBLE.

SAFETY PROTECTION EQUIPMENT MUST BE WORN BY PERSONNEL WHEN APPROACHING THROWN M47/XM47E3 AND M48/XM48E3 GRENADES, AS IT IS EXTREMELY DIFFICULT TO DISTINGUISH BETWEEN A FUNCTIONED, DUD, OR HANGFIRE GRENADE.

WHEN USING THE L96A1 AND L97A1 GRENADES, THE FOLLOWING PRECAUTIONS MUST BE TAKEN:

CS AND CA SMOKE CAN CAUSE IRRITATION TO THE EYES, MUCOUS MEMBRANES, AND SKIN. WEAR APPROPRIATE FACE PROTECTION SUCH AS AN M17 OR M40 SERIES PROTECTIVE MASK.

WARNING

WHEN USING THE M47/XM47E3 AND M48/XM48E3 HAND GRENADES, THE FOLLOWING PRECAUTIONS MUST BE TAKEN:

ADEQUATE EYE PROTECTION SHALL BE WORN BY TARGETED/OPPOSING FORCE PERSONNEL DURING BOTH AGENT AND CIVIL DISTURBANCE TRAINING EXERCISES.

ADEQUATE EYE PROTECTION SHALL BE WORN BY PERSONNEL DETAILED TO HANDLE DUDS/POSSIBLE HANGFIRES AND CLEAR TRAINING/ DEMONSTRATION/CIVIL DISTURBANCE OPERATION SITES.

TRAINING SITES AND CIVIL DISTURBANCE OPERATIONS SITES SHOULD BE CLEARED OF EXPENDED GRENADES AS SOON AS PRACTICABLE.

WHEN USING THE M90 SMOKE GRENADES, THE FOLLOWING PRECAUTION MUST BE TAKEN:

PROLONGED BREATHING OF OBSCURANT SMOKE CAN DAMAGE YOUR LUNGS. TO AVOID POSSIBLE INJURY, WEAR PROTECTIVE MASK WHEN ENTERING SMOKE CLOUDS.

NOTE

All personnel must wear the following eye protection equipment:

All targeted/opposing force personnel must wear field protective mask with eye piece outserts installed and face shield, plastic, riot control. Site clearance personnel must wear the above

specified equipment. When protective mask/face shield are either not available or their use is operationally unacceptable, safety glasses with side shields or safety goggles may be worn. The use of an industrial face shield as additional face protection is recommended. Only those devices meeting the ANSI Z87.1-1979, or equivalent standards, are acceptable.

Do not use smoke grenades in enclosed or confined areas.

Smoke grenades produce heat and are a fire hazard.

1-8. Care

- a. Keep grenades and components serviceable and ready for immediate issue and use.
- b. Keep all grenades and containers clean, dry and protected from damage.
- c. Do not disassemble grenades or explosive components without specific authorization.
- d. *Store* grenades and fuzes in original containers in a dry, well ventilated place protected from direct rays of sun and other sources of excessive heat..

1-9. Handling

WARNING

NEVER CARRY HAND GRENADES SUSPENDED BY SAFETY PULL RING, OR SAFETY CLIP.

- a. Handle grenades and components with care at all times. Particularly, prevent damage to stabilizer assembly of rifle grenade.
- b. Handle all grenades and components as potentially dangerous, even training items or those designated inert.
- c. Do not handle grenades by pull ring attached to safety pin or fuze.
- d. Carry hand grenades in ammunition pouch (fig. 1-6). (This pouch can carry five fragmentation hand grenades. Two grenades are strapped by the loop and three additional grenades are carried inside the pouch.)

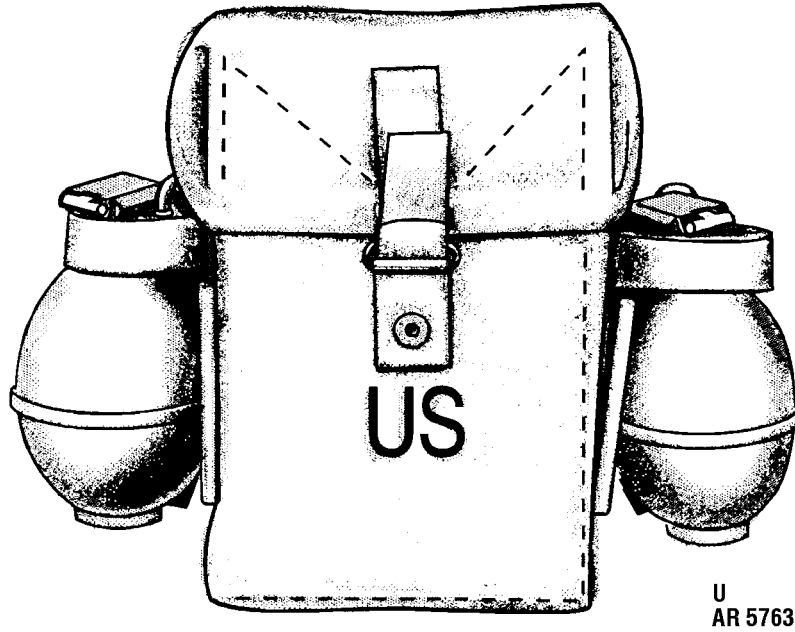

Figure 1-6. Ammunition pouch.

THIS PAGE INTENTIONALLY LEFT BLANK

CHAPTER 2 OPERATING INSTRUCTIONS

Section 1. OPERATION UNDER USUAL CONDITIONS

2-1. HAND GRENADE

WARNING

GRENADES M67, M33, M61, MB6A1, M26, Mk2, Mk3A2, Mk1, M34, M15, M54, M69, M62, M30. IF ANY OF THESE GRENADES ARE ACCIDENTALLY DROPPED AFTER REMOVAL OF SAFETY CLIP AND SAFETY PIN, IMMEDIATELY PICK UP GRENADE AND THROW IT INTO SAFE AREA.

GRENADES M68, M59 (M33 W/FUZE, M217) (M33A1), M57, M26A2. IF ANY OF THESE GRENADES ARE ACCIDENTALLY DROPPED AFTER REMOVAL OF SAFETY CLIP AND SAFETY PIN, IMMEDIATELY PICK UP GRENADE AND THROW IT INTO SAFE AREA. NEVER KICK OR THROW GRENADE INTO SUMP OR DITCH. WHEN THROWING, GUARD AGAINST BUMPING ARM OR HAVING GRENADE HIT ANY OBSTACLE.

GRENADES M18, AN-M8, M7, M7A1, M58, M7A2, M7A3, ABC-M25A1, ABC-M25A2, M83, M84, AN-M14, M25A2, M47, AND M48. NEVER PICK UP THESE GRENADES IF DROPPED AFTER REMOVAL OF SAFETY PIN. PERSONNEL SHALL MOVE IMMEDIATELY TO SAFE AREA. NEVER RELEASE HANDLE PRIOR TO THROWING GRENADE.

GRENADES M47 AND M48. THESE GRENADES PRESENT A RISK OF SERIOUS EYE INJURY IF THEY FUNCTION IN THE HANG FIRE (DELAY) MODE. A LONG TERM HANG FIRE (DELAY) IS POSSIBLE. SAFETY PROTECTION EQUIPMENT MUST BE WORN BY PERSONNEL WHEN APPROACHING THROWN M47 AND M48 GRENADES AS IT IS EXTREMELY DIFFICULT TO DISTINGUISH BETWEEN A FUNCTIONED, DUD, OR HANG FIRE GRENADE.

When using the M47 and M48 hand grenades, the following precautions must be taken:

WARNING

ADEQUATE EYE PROTECTION SHALL BE WORN BY TARGETED/OPPOSING FORCE PERSONNEL DURING BOTH AGENT AND CIVIL DISTURBANCE TRAINING EXERCISES.

ADEQUATE EYE PROTECTION SHALL BE WORN BY PERSONNEL DETAILED TO HANDLE DUDS/POSSIBLE HANG FIRES AND CLEAR TRAINING/ DEMONSTRATION/CIVIL DISTURBANCE OPERATIONS SITES.

TRAINING SITES AND CIVIL DISTURBANCE OPERATIONS SITES SHOULD BE CLEARED OF EXPENDED GRENADES AS SOON AS PRACTICABLE.

HC SMOKE CAN BE TOXIC IN HIGH CONCENTRATIONS. SEVERE RESPIRATORY DISTRESS OR EVEN DEATH CAN RESULT. ALL PERSONNEL WILL HAVE A PROTECTIVE MASK IMMEDIATELY AVAILABLE BEFORE SMOKE IS USED AND SHOULD MASK IF EXPOSED TO ANY CONCENTRATION OF SMOKE.

When using the M84 (stun) nonlethal hand grenade, the following precautions must be taken:

WARNING

ALL PERSONNEL MUST WEAR HEARING PROTECTION DURING TRAINING EXERCISES.

DO NOT ATTEMPT TO THROW THE GRENADE THROUGH GLASS OR WINDOW, SINCE IT MAY NOT BREAK THE GLASS OR WINDOW AND COULD BOUNCE BACK TOWARD THE USER.

DO NOT PRACTICE "COOK-OFF" WITH THIS GRENADE, SINCE IT HAS A SHORT FUZE DELAY TIME OF 1.0 TO 2.3 SECONDS.

THE M84 IS A ONE-TIME USE ITEM.

HUMAN TARGET PARTICIPATION IS NOT ALLOWED DURING TRAINING.

GRENADES SHOULD REMAIN IN SHIPPING/STORAGE CONTAINERS WHEN TRANSPORTED BY VEHICLE.

AVOID PROLONGED EXPOSURE SINCE THERE IS POTENTIAL FOR TOXIC FUME HAZARDS BUILDING UP IN ENCLOSED SPACES DURING TRAINING.

NOTE

All personnel must wear the following eye protection equipment.

1. All targeted/opposing force personnel must wear the field protective mask with eye piece outserts installed and face shield, plastic, riot control.
2. Site clearance personnel must wear the above specified equipment. When protective mask/face shield are either not available or their use is operationally unacceptable, safety glasses with side shields or safety goggles may be worn. The use of an industrial face shield as additional face protection is recommended. Only those devices meeting with ANSI Z87.1-1979, or equivalent standards are acceptable.

a. *Precautions.*

(1) If a grenade is accidentally dropped after safety clip, but not safety pin, has been released, pick up grenade and handle in normal manner.

(2) After release of safety clip (when installed) and removal of safety pin, throw grenade.

(3) Do not release safety clip (when installed) and do not pull safety pin until just before throwing grenade.

(4) Because burning-type grenades will flash occasionally and cause personnel injury, throw grenade so as to function at least 10 meters from friendly personnel.

(5) Have personnel take cover immediately after throwing or projecting WP; offensive, illuminating, practice; or fragmentation grenades.

(6) In throwing grenades, avoid hitting obstacles which can change course of grenade or cause it to bounce back.

(7) Since fragments may be projected over 185 meters, do not use fragmentation grenades in training without adequate cover (see FM 3-23.30).

(8) Because WP particles cause burns and fires, throw WP grenades used in training so that they will burst more than 35 meters away from all personnel, unless protection is afforded.

NOTE

Particles of WP may not burn in moist areas but will ignite under drier conditions. WP can be expected to start fires several days after maneuvers or training exercises.

(9) Observe 30-minute waiting period prior to approaching dud. Have duds destroyed in place only by authorized disposal personnel.

(10) Wait 5 minutes before removing fired practice hand grenade to allow grenade body to cool.

(11) Do not throw smoke grenades unless personnel are at least 15 meters away from anticipated point of impact.

(12) Refer to appropriate rifle operator manuals for prescribed rifle launcher/cartridge combinations to launch hand grenades fitted with adapters.

b. *Preparation for Use.*

(1) *Hand grenades furnished assembled.*

(a) Cut strapping on pallet and/or box.

(b) Cut box seal and open box.

(c) Remove inner container(s) from packing box.

NOTE

As issued, grenades are packed in their containers with fuzes up.

(d) For all grenades except M47 and M48, pull off sealing tape. Carefully remove cover or lid of cylindrical container and packing support from top of grenade (fig. 2-1). Proceed to (f) below.

(e) For grenades M47 and M48: Open barrier bag by slitting along edge having most free material. Remove inner styrofoam tray from barrier bag.

(f) Assure that safety pin and safety clip (when installed) are in place and undamaged and that legs of safety pin have either angular spread or diamond crimp.

WARNING

IF HAND GRENADE IS PACKED UPSIDE DOWN (FUZE DOWN) (FIG. 2-2), OR RIGHT SIDE UP (FUZE UP) WITH SAFETY PIN NOT IN PLACE (FIG. 2-3), DO NOT ATTEMPT TO REMOVE GRENADE FROM ITS CONTAINER.

WHEN EXPOSED TO RED PHOSPHORUS (RP) OR HEXACHLOROETHANE (HC) SMOKE OR ANY RIOT CONTROL AGENT, THE FOLLOWING PRECAUTIONS APPLY:

RED PHOSPHORUS SMOKE, HC SMOKE, OR ANY RIOT CONTROL AGENT MAY PRESENT AN INHALATION OR IRRITANT HAZARD. PROLONGED EXPOSURE OF THE EYES AND RESPIRATORY SYSTEM SHOULD BE AVOIDED. WEAR PROTECTIVE MASKS TO AVOID EXCESSIVE EXPOSURE.

NOTE

Do not use smoke grenades in enclosed or confined areas.

Smoke grenades produce heat and are a fire hazard.

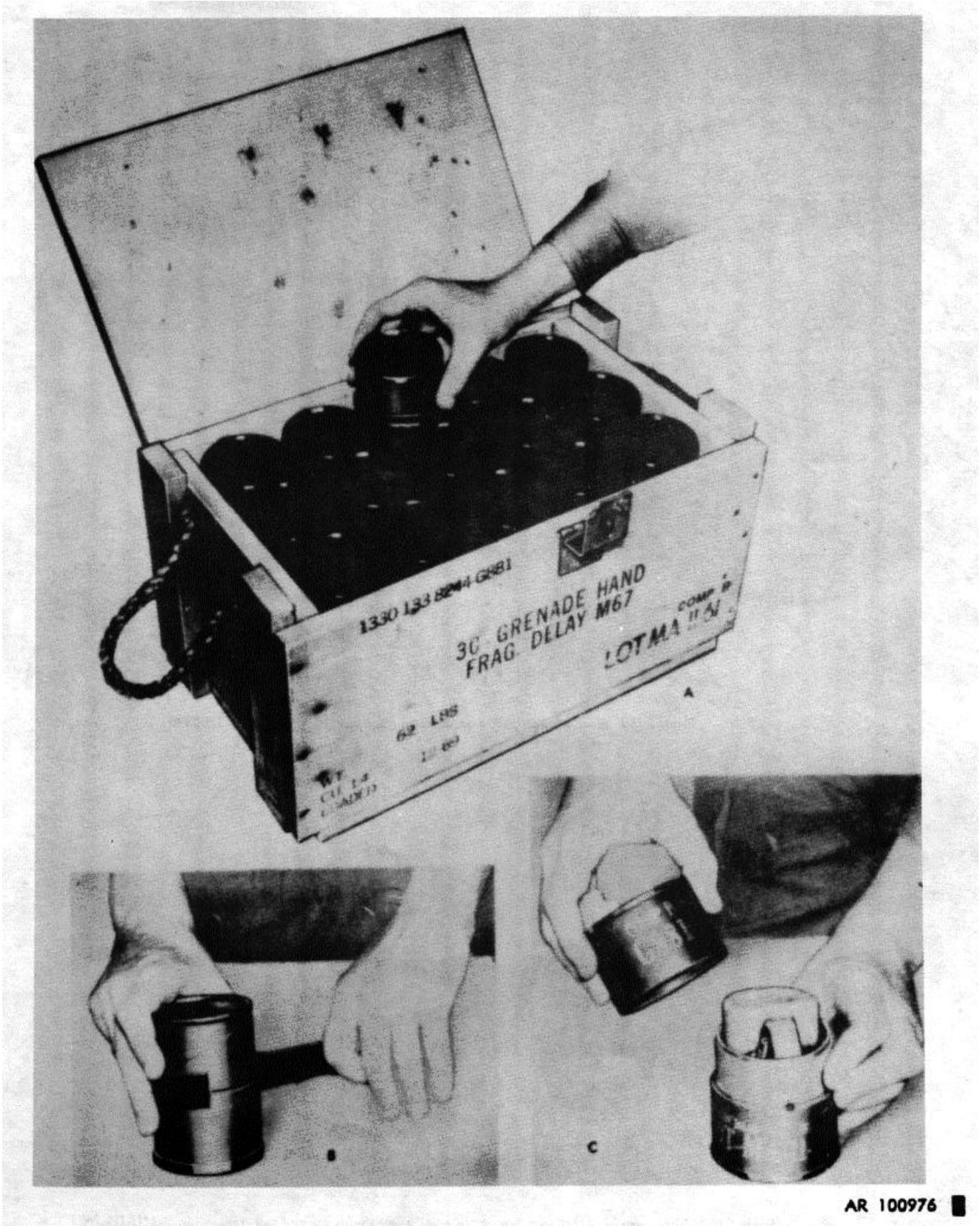

AR 100976 ■

Figure 2-0. Inspection of grenades. AR1000976

Change 8 2-2.1

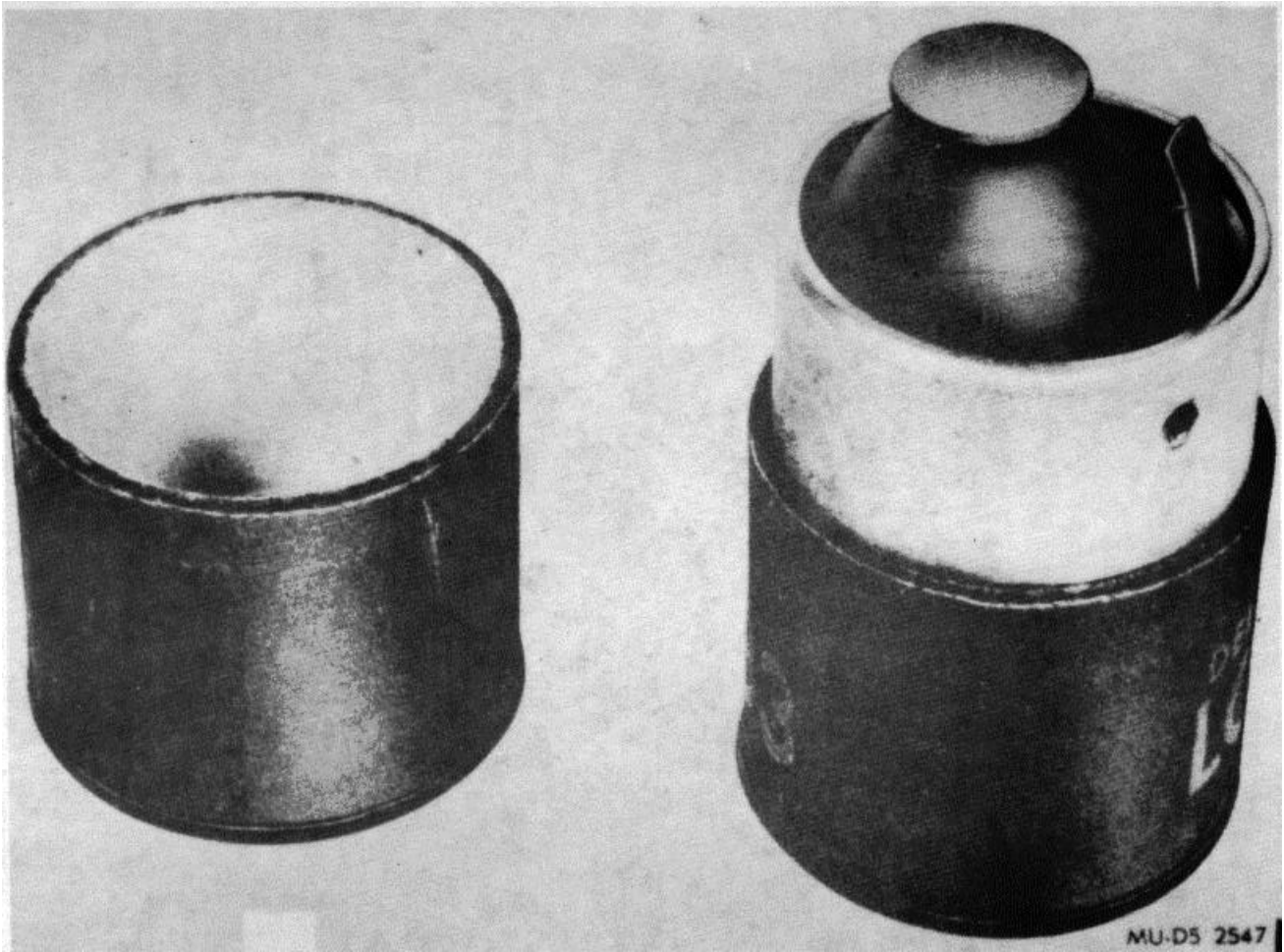

Figure 2-0.1 Hand grenades packed upside down (fuze down). MU-D5 2547

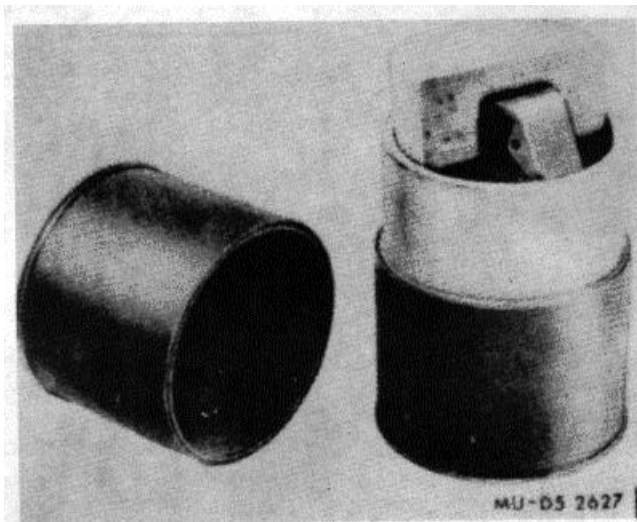

Figure 2-0.2. Hand grenades packed right side up (fuze up) without safety pin and pull ring. MU-D5 2627

Replace cover, and tape in place. Identify defect(s) and return container to ammunition disposal personnel.

(g) Remove grenade from container and inspect for obvious defects, (e.g., cracked grenade body, broken fuze lugs, damaged safety lever (fig. 2-1), damaged safety pins or pull rings, damaged safety clips (when installed) and *loose fuzes*, which would impair functioning or present a *safety hazard in handling*. Dispose of defective grenades as indicated in WARNING, above.

NOTE

If the grenade safety clip (when installed) is not in position, secure it in position as indicated in paragraph 3-7a(7).

NOTE

Save some packaging material for repacking of unused items; also, save components of containers in order to repack retained items. Send excess packaging material to organizational maintenance for their use.

(h) Following criteria are applicable to fuze safety lever hinge ear engagement (fig. 2-1.1). Inspection shall be made with safety clip and safety pin in place. Defective items shall be referred to organizational support personnel for corrective action.

1. Either of the two hinge ears missing.
2. Body lug damaged.
3. Hinge ear that does not appear to extend beyond the vertical center line of fuze body lug.
4. Hinge ear that does not appear to terminate in an upward direction.

(i) If defects listed in 3 or 4 above are evident, restore ears to their original position around lugs using an improvised non-metallic tool (approximately 1/8 in. thick, Y2 in. wide, 6 in. long) (fig. 2-1.2). If defects listed 1, 2, 3, and 4 are nonrepairable dispose of as indicated in WARNING, (para 2-1b()).

(2) Practice hand grenades are furnished unassembled.

WARNING

Never attempt to use grenade body which has any sign of metal failure.

(a) Inspect practice grenade body for foreign matter in body cavity or in openings. Also, inspect for signs of metal failure (cracks or bulges).

(b) Assure that port hole in base of body is not blocked.

(c) Return defective practice grenade bodies to ammunition supply personnel for disposition.

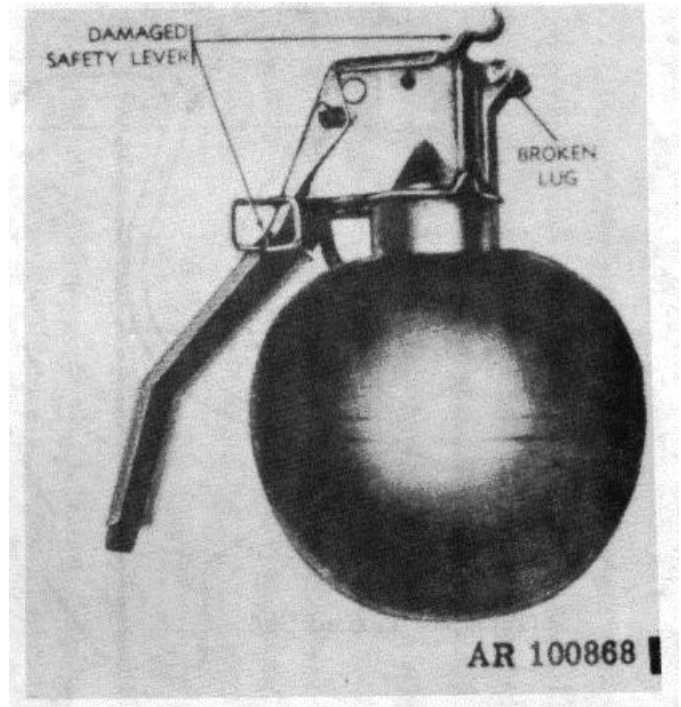

Figure 2-1. Grenade with damaged safety lever and broken fuze lugs.

WARNING

Never attempt to remove any grenade fuze from its packing if safety pin is missing. Identify defect(s), replace packing and return fuze to ammunition supply personnel for disposition. Never handle fuzes by pull rings or by grasping detonator assembly.

(d) Remove fuze from packing and inspect for deformation, cracks, or corrosion.

WARNING

When assembling fuze to body of grenade, do not face port hole toward personnel, or cover with hand.

(e) Holding fuze in one hand, screw body onto fuze (fig. 2-2). Assure that fuze is firmly seated on grenade neck.

NOTE

The hand grenade safety clip (when installed) is assembled to the grenade and positioned around the safety lever. With the safety dip positioned on the grenade, the safety lever will not be released if the safety pin is accidentally removed. The safety dip is a supplement.

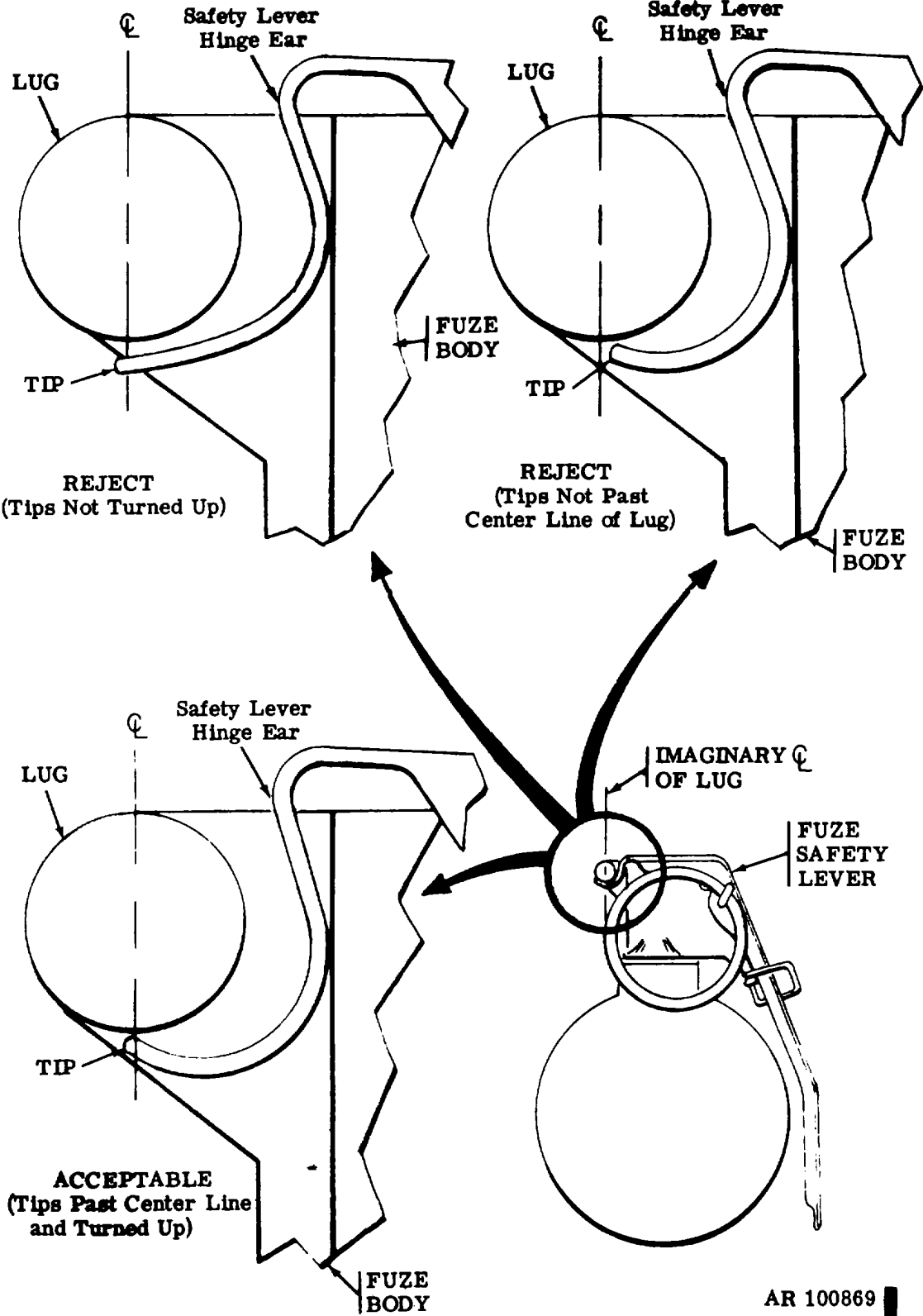

AR 100869

Figure 2-1.1. Criteria for hinge ear engagement (tips past center line and turned up.)

tary device to the safety pin. It is not a substitute for the safety pin.

(f) safety clip on Grenade M69 as shown in figure 2-3.

(g) Assemble safety clip for Grenade M62 as follows:

1. Pick up safety clip by the handle and slide on lever, as show in 1, figure 2-4.
2. Press loop portion around washer under fuze (2, fig. 2-4)
3. Snap safety clip handle around fuze safety lever in 3, figure 2-4.

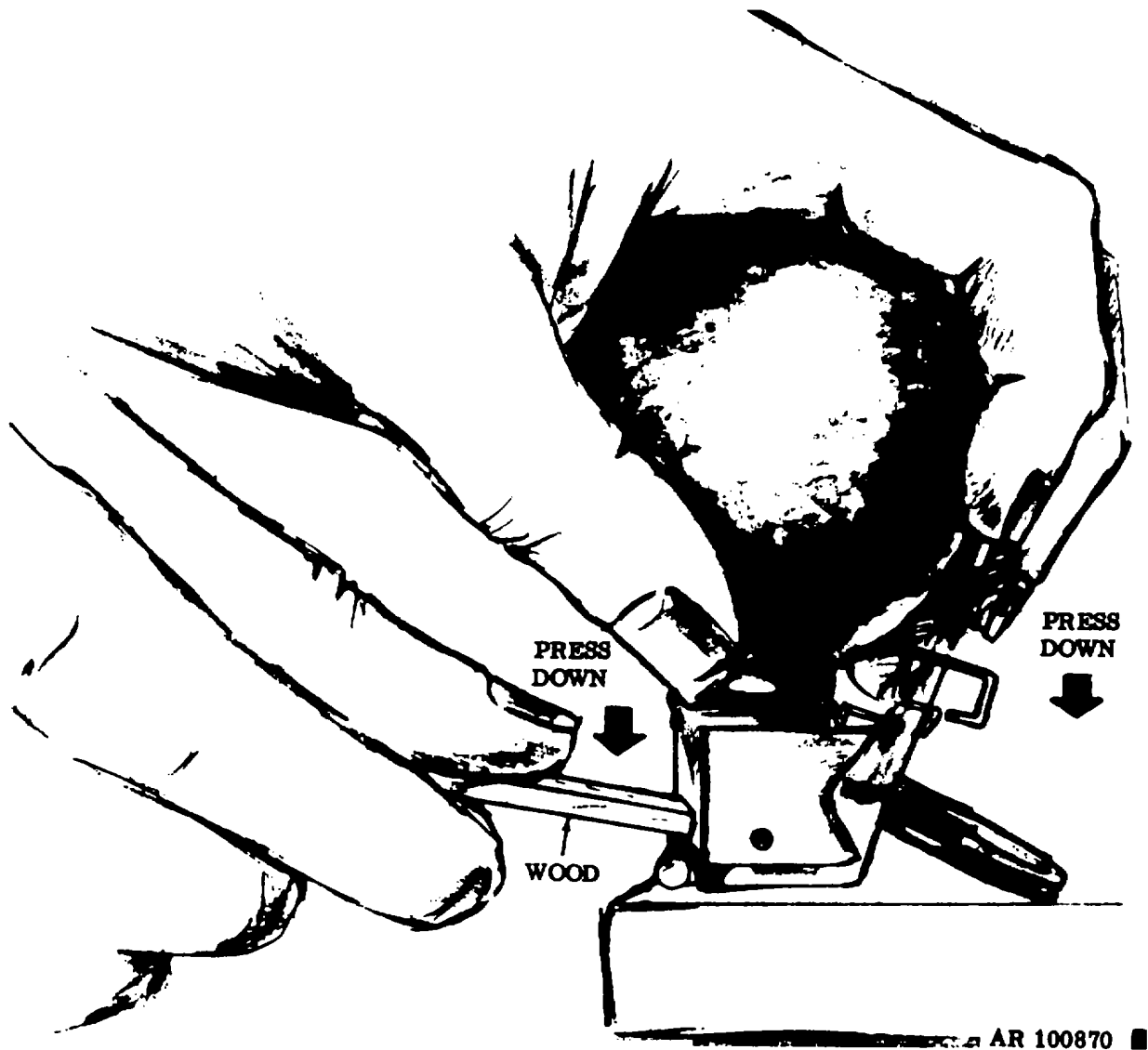

Figure 2-1.2. Fuze safety hinge ear repair.

Change 8 2-2.5 (2-2.6 blank)

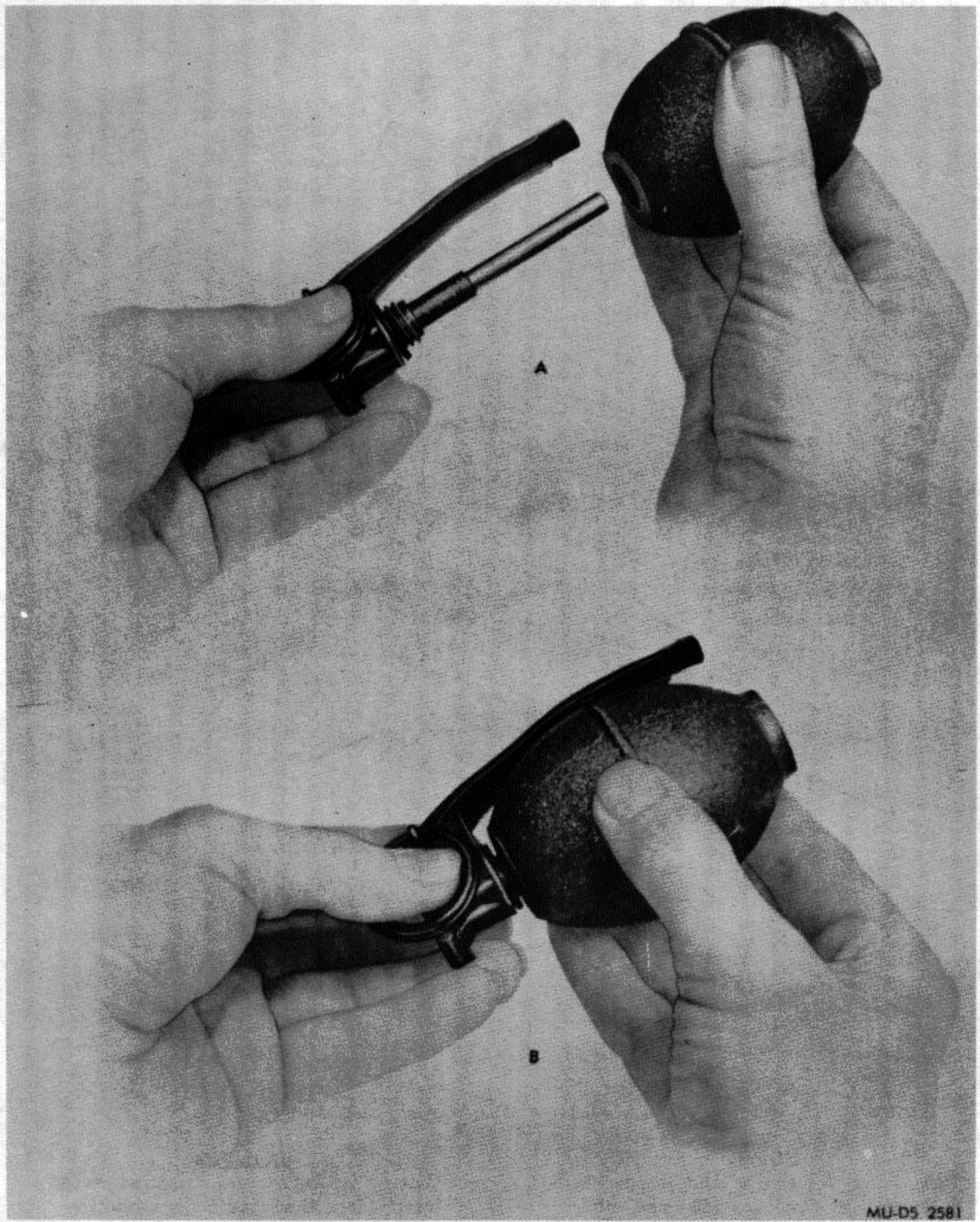
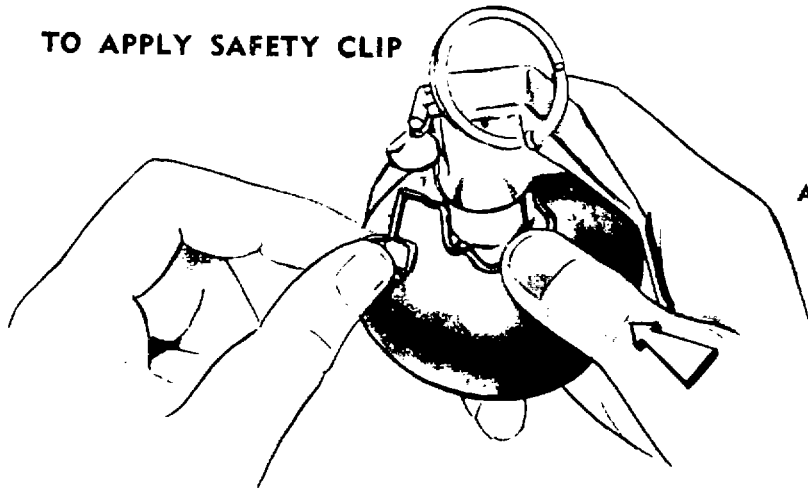
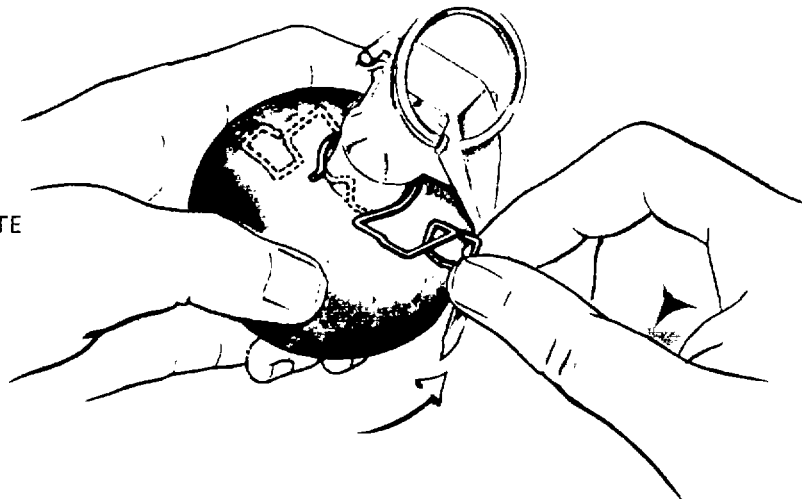

Figure 2-2. Screwing practice grenade body onto fuze.

TO APPLY SAFETY CLIP



A. WITH GRENADE HELD IN RIGHT HAND, PLACE CLIP AS SHOWN. PRESS FORWARD WITH RIGHT THUMB TO SECURE CLIP TO NECK OF GRENADE BODY.



B. TRANSFER GRENADE TO LEFT HAND AND ROTATE CLIP 180 DEGREES TO POSITION SHOWN.

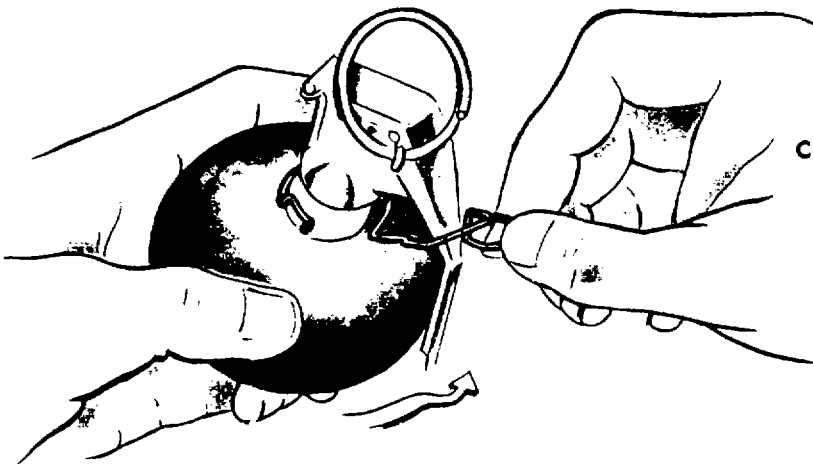

C. WITH GRENADE STILL HELD IN LEFT HAND, LIFT CLIP ACROSS FUZE HANDLE AND SNAP IN PLACE AS SHOWN.

MU-L2093

Figure 2-3. Assembly of safety clip to grenade M69.

NOTE

Use of practice charge and stopper is optional with Grenades M30 and M62. Neither is used with Grenade M69.

WARNING

When practice charges are used, never insert more than one charge into grenade. Do not substitute any other explosive for authorized practice charge.

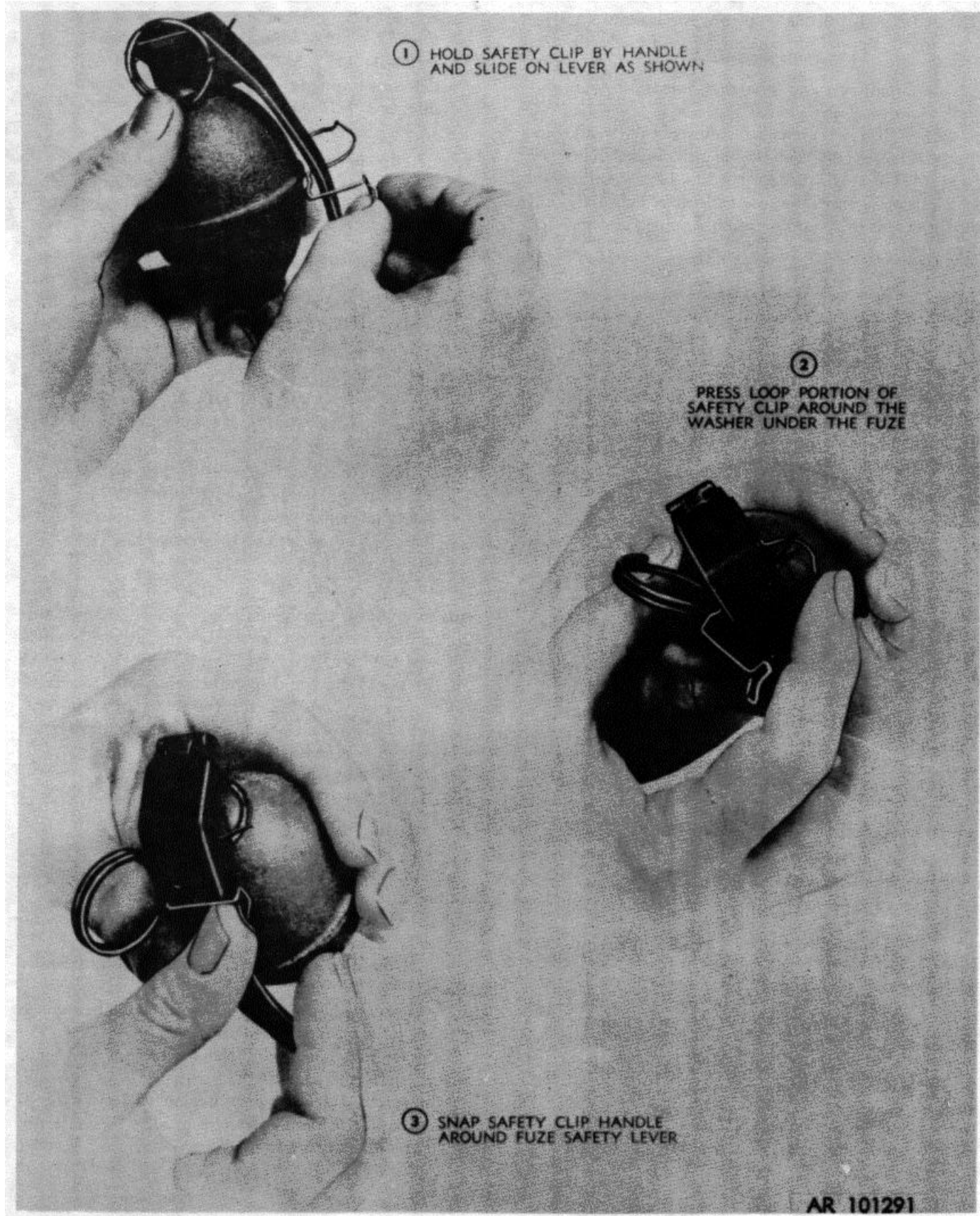

Figure 2-4. Assembly of safety clip to grenade M62.

(h) Carefully insert one practice hand grenade charge in body through opening in bottom (A, fig. 2-5). Insert stopper in hole in base of body (B, fig. 2-5).

(3) *Offensive hand grenades furnished unassembled. (Navy only)*

(a) Remove grenade from container and inspect for obvious defects (e.g., cracks, cuts or gouges, damaged threads, splits or indentations) which would preclude use. Identify defect(s), and turn grenade in to ammunition supply personnel for disposition.

(b)

WARNING

Never attempt to remove any grenade fuze from its packing if safety pin is missing. Identify defect(s), and return fuze to ammunition disposal personnel.

Remove fuze from its packing and inspect for deformation, cracks, thread damage and corrosion. Dispose of defective fuzes as indicated in WARNING, above.

(c)

CAUTION

Never handle or carry fuzes by holding the detonator. Handle and carry holding fuze body only.

Assure that safety clips used with offensive hand grenade are assembled to fuze prior to assembly of fuze to grenade.

(d) To assemble safety clip to Fuze M206 Series, hold fuze body between thumb and fingers with pull ring up and detonator pointing away from operator. Pick up safety clip and handle with closed end of loop toward operator and proceed as follows:

1. Pass open end of loop over detonator and onto thread of fuze body (1, fig. 2-6).

2. Press loop of safety clip around fuze washer with tab of loop against fuze body (2, fig. 2-6).

3. Rotate clip handle over safety lever (3, fig. 2-6).

(e) Holding fuze in one hand, screw body onto fuze (fig. 2-7).

NOTE

Safety clip must not bind under washer after assembly.

c. *Operation.* Prepare hand grenades for throwing as follows:

WARNING

In throwing grenades, avoid hitting

obstacles which can cause grenade to change course or bounce back. Rolling or bouncing Grenades M68, M59 (M33 w/Fuze M217) (M33A1), M57, M-26A2 toward target will detonate grenade approximately 1 second after handle is released.

WARNING

Require personnel handling grenades M47 or M48 to use field protective masks. Avoid throwing grenades M47 and M48 at targets of flammable material.

(1) Hold grenade in throwing hand with thumb holding safety lever (arming sleeve on Riot Control Agent Grenades ABC-M25A1, ABCM25A2) firmly against grenade body.

(2) Release safety clip when installed by using thumb of free hand.

WARNING

During release of safety clip (when installed) and removal of safety pin, hold safety lever firmly in place until grenade is thrown, tossed, or placed in position. (Failure to hold safety lever firmly in place may result in release of fuze striker and subsequent functioning of grenades.)

(3) With free hand, pull safety pin, holding grenade safety lever tightly against grenade body or maintaining pressure on arming sleeve of chemical Grenades ABC-M25A 1 and ABC-M25A2.

d. *Prepared for Use.* When the safety clip (when installed) has been released and the safety pin removed, the grenade is armed and must be thrown. Never attempt to replace the safety pin.

2.2. Rifle Grenades

a. *Precautions.*

(1) Use only prescribed rifle-launcher-cartridge combination, as shown in applicable rifle operator manuals, to launch rifle grenades.

(2) Always check rifle to assure that it contains no service ammunition.

(3) Do not fire rifle grenade over heads of friendly troops.

(4) Never place rifle grenade on launcher unless grenade is to be fired immediately.

(5) Remove safety wire from Grenade M 19-A I and safety clip from Grenade M22 Series just prior to firing. Retain safety clip or wire. Replace safety wire in M19A1 (A, fig. 2-8) or safety clip in M22 Series (B, fig. 2-8) if grenades are not fired.

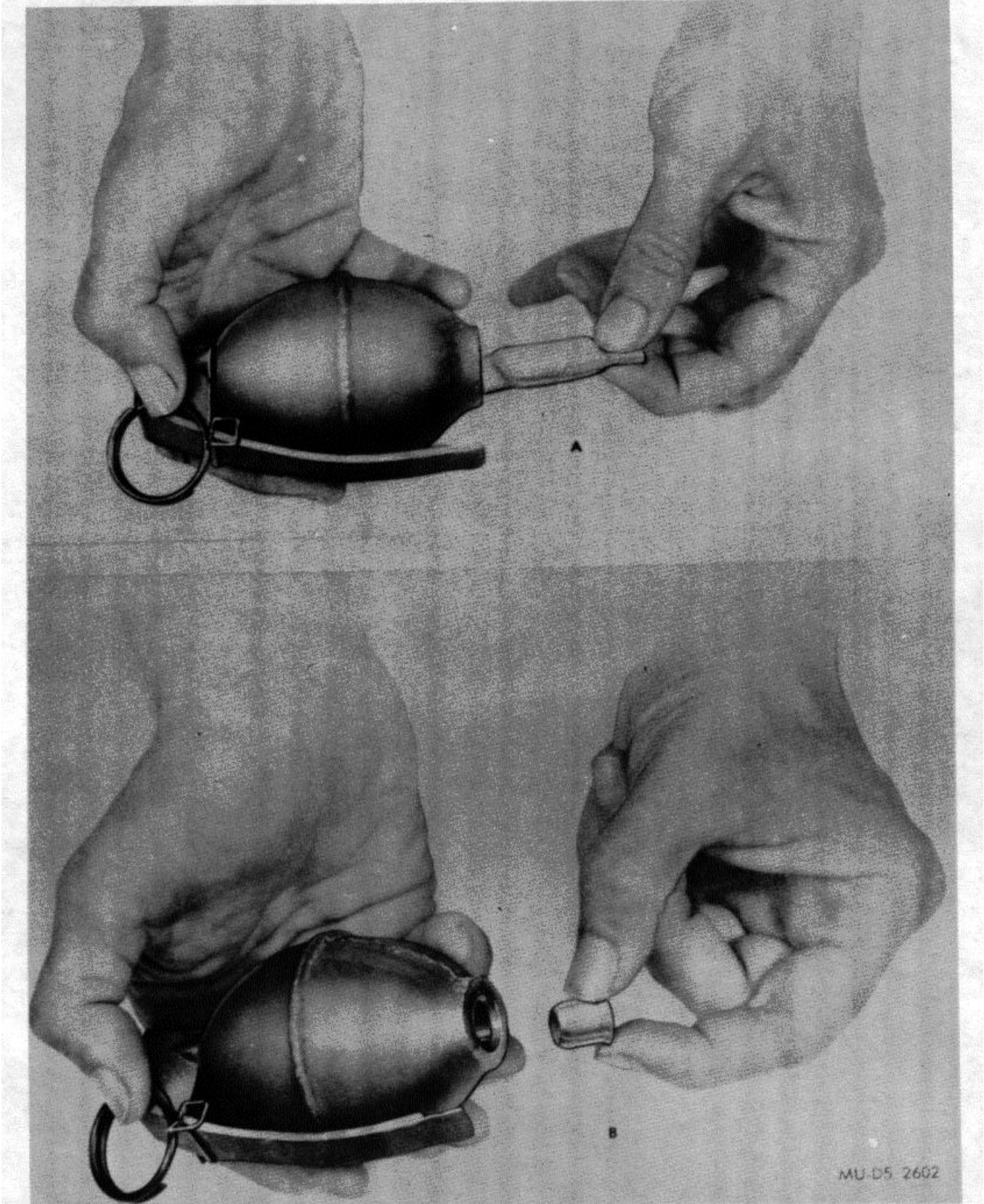

Figure 2-5. Insertion of practice charge and plastic stopper

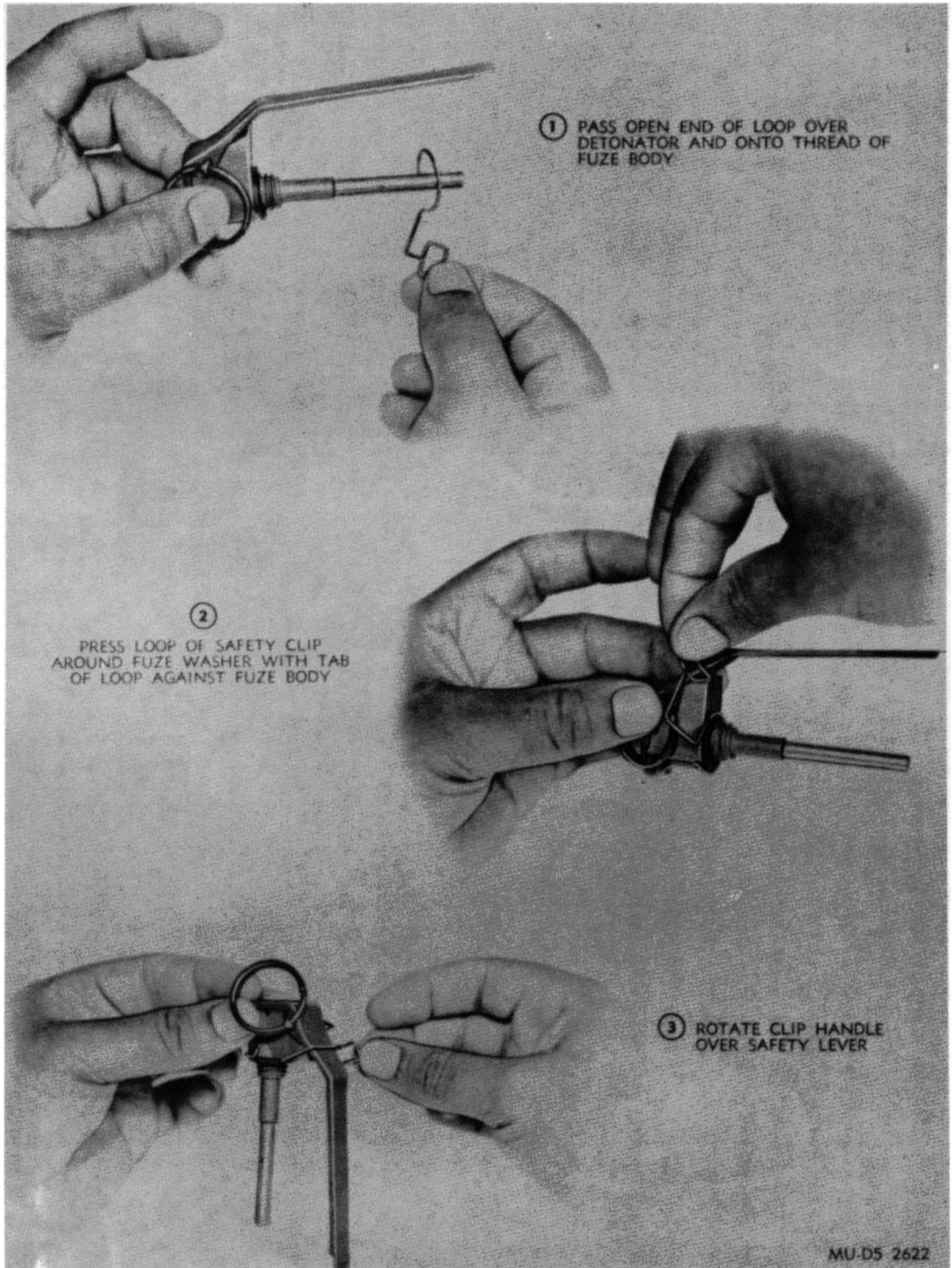

Figure 2-6. Assembly of safety clip to fuzes M206 series.

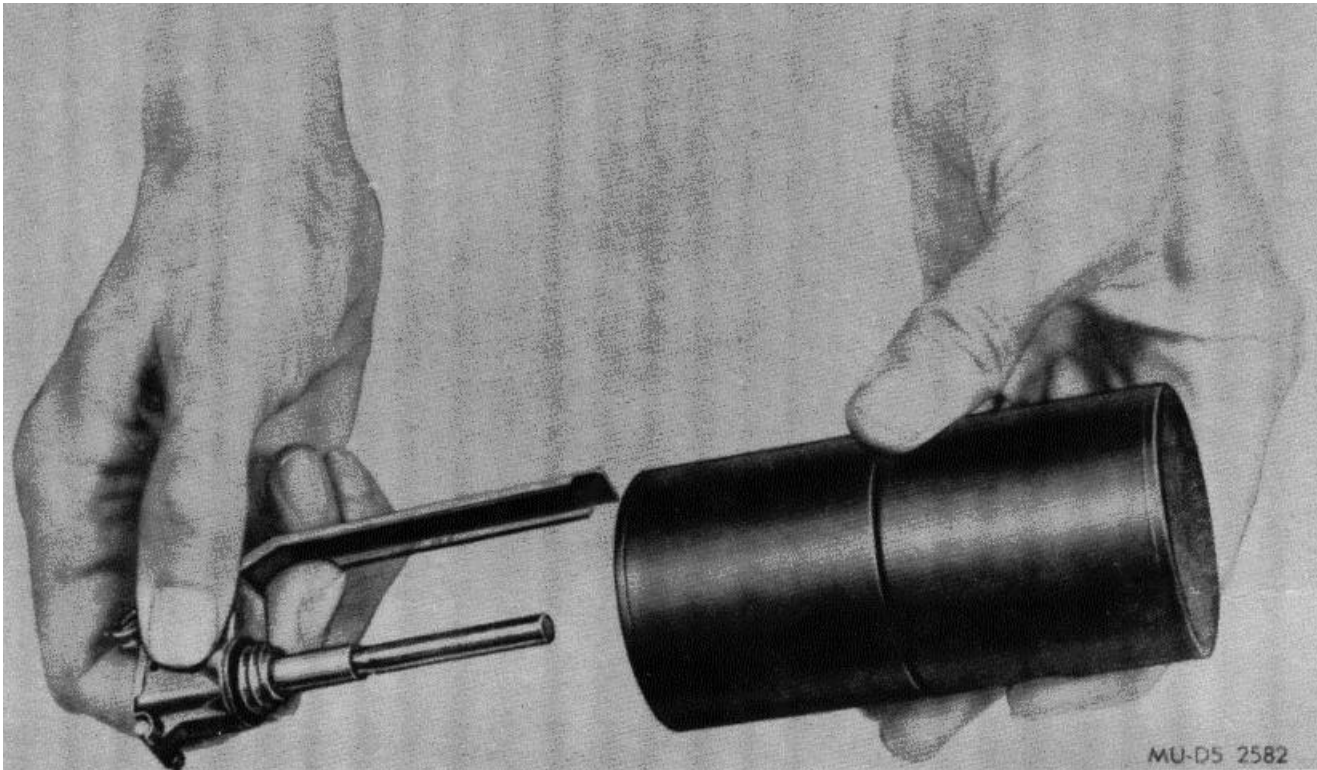

Figure 2-7. Screwing offensive grenade body onto fuze.

(6) Remove tape from vent in nose of Smoke Rifle Grenade M23 Series just prior to firing. Replace tape if grenade is not fired.

(7) Do not puncture or disassemble rifle grenades.

b. Preparation for Use.

(1) Remove container from packing box.

(2) Open container and remove rifle grenade.

(3) See that safety wire in Grenades M19A1 and safety clip on Grenades M22 Series are in place. If safety wire or safety clip is not in place, but available, install as indicated in figure 2-8. If safety wire or safety clip is not available, leave grenade in place and contact authorized disposal personnel for disposition.

(4) Inspect Rifle Grenades M31 for condition of nose protector cap. If cap is dented, return grenade to ammunition supply personnel for disposition.

(5) Inspect stabilizer tube and fin assembly. If either is dented or deformed, return grenade to ammunition supply personnel for disposition.

c. Operation. For rifle grenade firing procedures, refer to applicable rifle operator manuals. For tactical use of rifle grenades, refer to FM 2330.

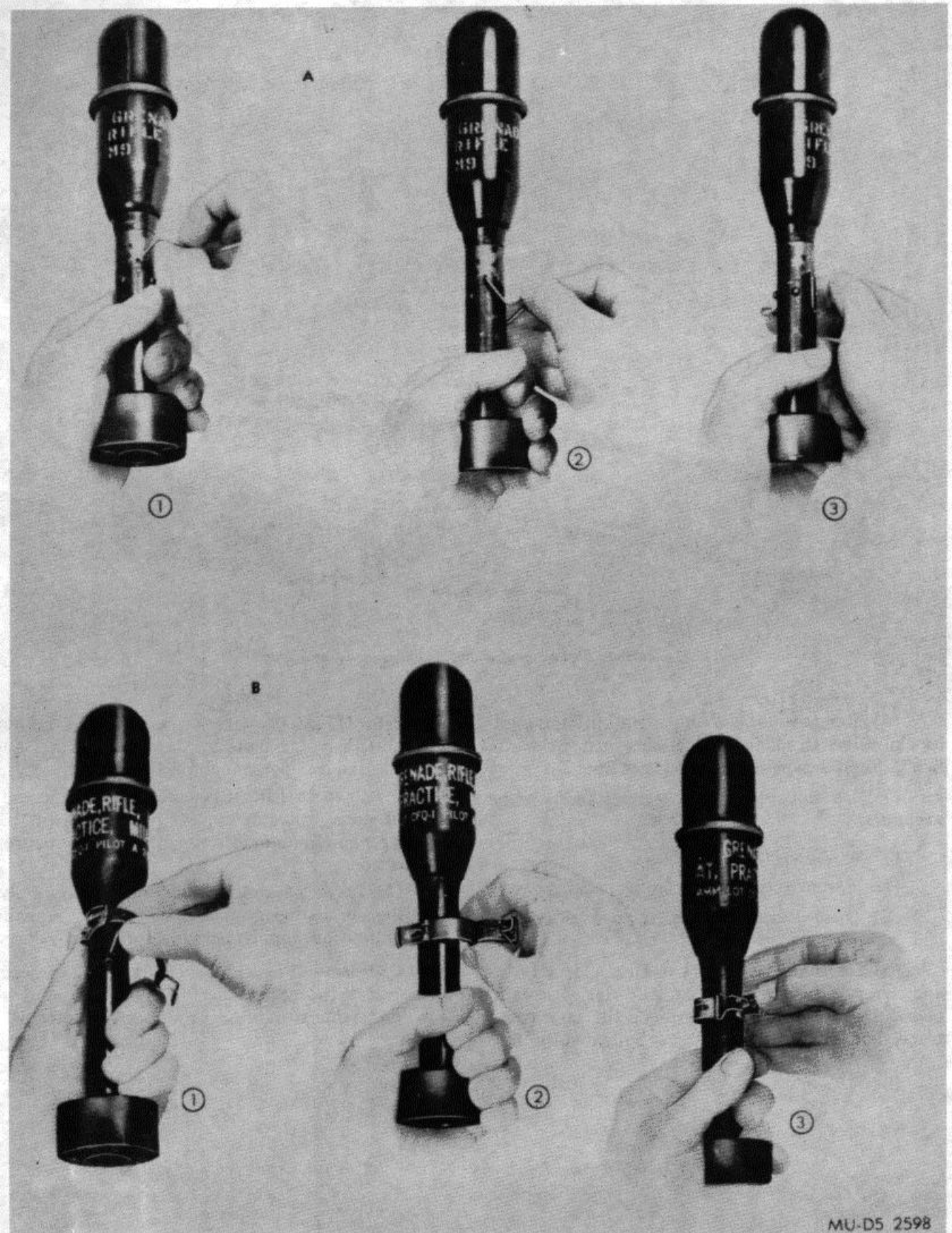

Figure 2-8. Replacement of safety wire and safety clip.

2-3. Launcher Grenades

WARNING

A PHOSPHINE GAS ATMOSPHERE IS GENERATED FROM THE SMOKE MIX IN L8A1 AND L8A3 GRENADES. AS A RESULT, THE FOLLOWING SAFETY HANDLING GUIDANCE IS TO BE OBSERVED. STORE ALL L8A1, L8A3 GRENADES IN A VENTILATED AREA OR MAGAZINE. STORAGE MAGAZINES CONTAINING THESE GRENADES WILL BE OPENED AND ALLOWED TO VENTILATE THREE TO FIVE MINUTES PRIOR TO ENTRY BY PERSONNEL. THESE GRENADES SHALL ONLY BE UNPACKED OUT OF DOORS OR IN A WELL VENTILATED AREA. DO NOT OPEN STORAGE CONTAINERS IN THE VICINITY OF AN OPEN FLAME OR FLAME PRODUCING DEVICES.

WHEN FIRING L8A1, L8A3 GRENADES INTO A STRONG HEAD WIND, A MINIMUM SAFE DISTANCE OF 125 METERS FOR PERSONNEL OUTSIDE THE VEHICLE SHOULD BE MAINTAINED. IF THIS DISTANCE CANNOT BE MAINTAINED, PERSONNEL MUST BE PROTECTED FROM RED PHOSPHOROUS FRAGMENTS HITTING BARE SKIN (i.e., LONG SLEEVES, HEAD, HAND AND FACE PROTECTION). CLOTHING WILL FIT SNUGLY TO PREVENT RED PHOSPHOROUS FROM GETTING INSIDE.

WHEN FIRING THE M90 GRENADES, THE FOLLOWING PRECAUTIONS MUST BE TAKEN:

DO NOT FIRE GRENADES WHEN PERSONNEL OR EQUIPMENT ARE WITHIN 75 METERS COVERING AN ARC OF 90 DEGREES AROUND A FIRING DISCHARGER.

HIGH INTENSITY NOISE IS PRESENT WHEN FIRING GRENADES. DURING FIRING TRAINING, PERSONNEL WITHIN 1/2 METER MUST WEAR SINGLE HEARING PROTECTION.

TO AVOID POSSIBLE INJURY FROM FIRED GRENADE, WEAR PROTECTIVE EYEWEAR AND ROLL DOWN SHIRT SLEEVES IF STANDING IN TURRET AREA.

DO NOT USE ANY GRENADE IF DAMAGE IS NOTED TO THE GRENADE END CAP OR ALUMINUM BODY. SET ASIDE FOR DISPOSAL.

WHEN FIRING THE L96A1 AND L97A1 GRENADES, THE FOLLOWING PROCEDURES MUST BE TAKEN:

DO NOT FIRE GRENADES WHEN PERSONNEL OR EQUIPMENT ARE WITHIN 150 METERS COVERING A 90" ARC AROUND THE FIRING DISCHARGER.

DURING FIRING TRAINING, PERSONNEL WITHIN 16 METERS MUST WEAR SINGLE HEARING PROTECTION. THIS INCLUDES PERSONNEL WITHIN VEHICLE.

WARNING

DO NOT FIRE THESE GRENADES AT THE 50M OR 75M POSITIONS ON THE M315 ADJUSTABLE AIMING BRACKET. FIRE ONLY AT THE 100M SETTING.

THE BURNING GRENADE CANISTERS COULD START A FIRE IN DRY GASSES. KEEP A FIRE EXTINGUISHER AVAILABLE

a. *Precautions.*

(1) Handle grenades with care, avoid damage and observe normal safety precautions.

(2) Do not disassemble grenades or make unauthorized modifications.

b. *Preparation For Use.*

(1) Cut steel strapping with shears.

(2) Remove metal ammunition box.

(3) Open metal box.

(4) Remove packing and grenades.

NOTE

Save some packing material for repacking of unused items.

(5) Inspect each grenade in accordance with the requirements of paragraph 3-7c prior to use.

NOTE

There are no repair parts for the L8A1, L8A3 M76, M82, M90, L96A1, and L97A1 grenades.

c. *Operation.* Refer to the appropriate operator's manual for operational procedures.

Section II. OPERATION OF MATERIEL USED IN CONJUNCTION WITH MAJOR ITEMS

2-3. Grenade Projection Adapters

a. Applications. Grenade projection adapters are devices designed to adapt hand grenades for launching from rifles assembled with grenade launchers, thus extending their range. Grenade projection adapters consist of a stabilizer tube with a fin assembly on one end and gripping claws on the other end. The claws, of spring steel, grip the hand grenade and hold it in place on the adapter. Grenade projection adapters may be used with service and practice hand grenades as indicated in table 2-1.

(2) When safety clip (when installed) has been released and safety pin removed, grenade is armed. Launch immediately.

(3) Keep adapters clean and dry, particularly on inside of stabilizer tube. Do not use adapters with cracked or distorted stabilizer tubes. Check that grenade fits on adapter. Assure that adapter moves freely on launcher.

(4) Never place grenade on launcher unless it is to be fired immediately. Do not attach grenades to launcher as means of carrying grenades.

(5) Normally, grenades are prevented from falling off launcher by grenade retainer spring; however, when firing at minus (depressed) angle of elevation, lower rifle gently to prevent weight of grenade from causing it to slip from launcher.

(6) Do not handle duds. Report their location to authorized disposal personnel.

Table 2-1. Grenades Used with Grenade Projection Adapters

| Grenade projection adapter | Grenades |
|----------------------------|--|
| M1 | Grenade, Hand: Fragmentation, Mk2 |
| M1A1 & M1A2 | Grenade, Hand: Illuminating, Mk1 Grenades, Hand: Fragmentation, M61, M26A1, M26, Mk2, M62, M30 Grenade, Hand-Rifle: Smoke, WP, M34 |
| M2 & M2A1 | Grenade, Hand: Riot, CN, M & M7A1 Grenade, Hand: CS, ABC-M7A2 and ABC-M7A3 Grenade Hand: Smoke, HC, AN-M8 Grenade, Hand: Incendiary, TH3, AN-M14 Grenade, Hand: 8 to 12 Second Delay, CS, M54 Grenade, Hand: Colored Smoke (Red, Green, Yellow or Violet) M18 |

c. Adapters, Grenade Projection, M1-Series.

(1) *Applications.* Grenade Projection Adapters M1 Series are used to adapt fragmentation, practice, illuminating and WP smoke hand grenades for launching from a rifle equipped with a grenade launcher. Three different models are available: the M1, the M1A1 and the M1A2 (fig. 2-9). Fragmentation hand grenades can be projected a maximum of 160 meters when fired from a rifle using Grenade Projection Adapters M1 Series.

(2) *Preparation for use.*

NOTE

Hand Grenades M68, M59 (M33 w/Fuze M217) (M33A1), M57, M26A1 are not to be launched from a rifle.

b. Precautions. In addition to precautions listed in paragraph 2-1a, and the precautions listed for particular grenade to be used, observe following precautions in launching grenade projection adapters assembled with hand grenades: (1) Never release safety clip and remove safety pin from hand grenade until just before firing.

WARNING

Do not use grenade having bent or damaged safety lever with grenade projection adapter. Be sure base of grenade is fully seated against base of cup and that each claw holds grenade tightly above seam of Grenade M61, M26 or M30, or in body serrations of Grenades Mk2, or in annular ring of M34. Do not apply force to arming clip of adapter after grenade has been attached.

CAUTION

Do not use damaged adapters.

(a) Inspect grenade to make sure safety pin and safety clip are securely in place, and safety lever is not damaged or bent.

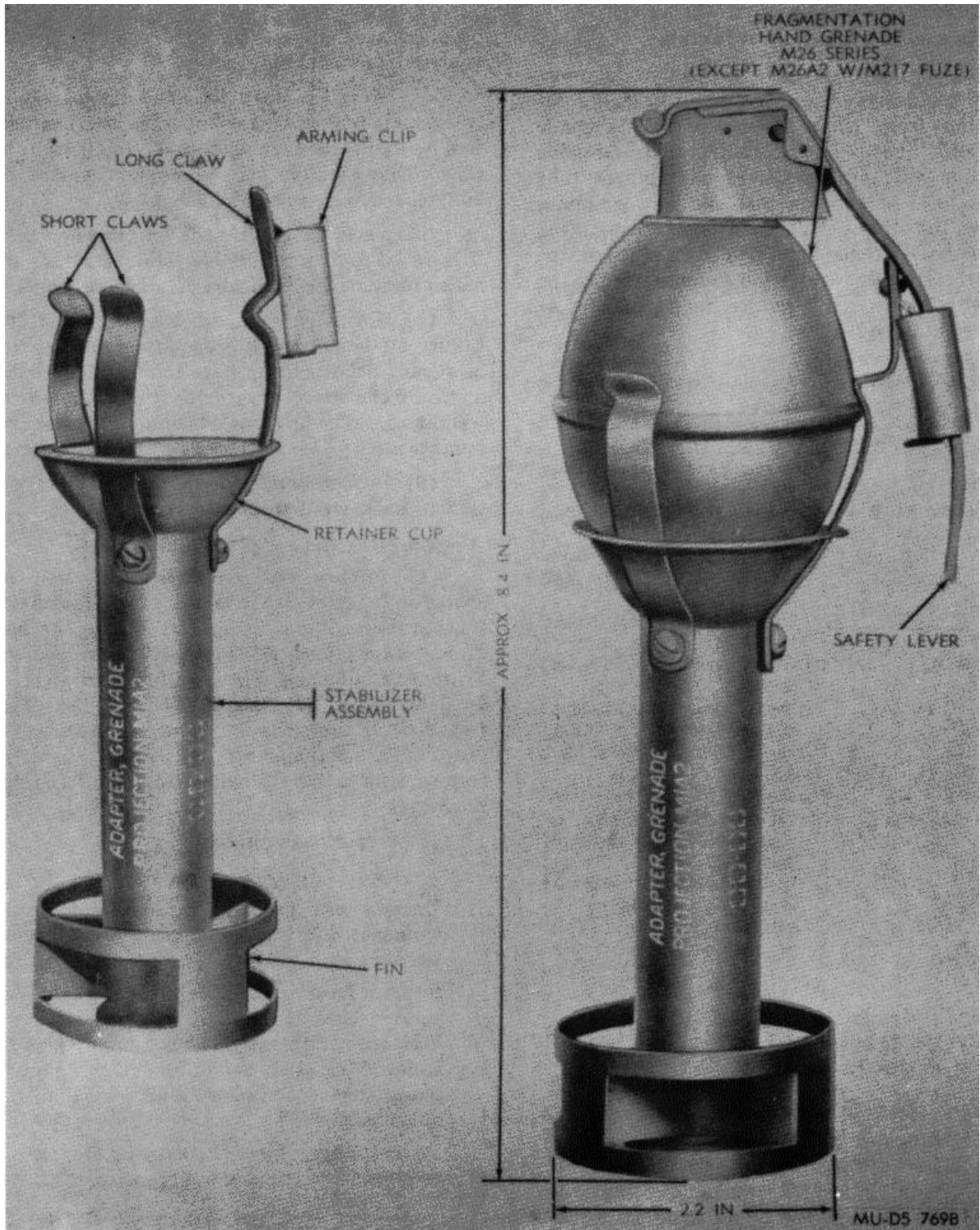

Figure 2-9. Grenade projection adapter M1A2.

(b) Inspect grenade projection adapter for bent, cracked, or damaged stabilizer tube or fin assembly.

(c) Insert safety lever of grenade into arming clip of adapter.

(d) Force grenade into claws until base of grenade is resting in cup (or against end of stabilizer tube of Adapter M1).

(e) Inspect safety lever to see that its end is securely hooked under T-lug of fuze body.

(f) Place hand grenade with grenade projection adapter on launcher and push it to desired annular groove.

NOTE

When a number of grenades are to be launched with the adapter set at the same annular groove, the launcher positioning clip may be used. The clip is snapped into position at the desired annular groove, and serves as a positioning stop for the adapter placed on the launcher.

(3) *Operation.* Prepare all hand grenades with projection adapters for launching as follows:

WARNING

Do not release safety clip and safety pin until ready to fire. If arming clip fails to hold safety lever securely in place and/or striker has been released, immediately launch grenade into safe area and take cover.

(a) Holding safety lever in arming clip with thumb of one hand, and being careful not to put any strain on arming clip, carefully release safety clip (when installed) and remove safety pin with other hand.

(b) Slowly ease pressure on safety lever; see that lever is held in place by arming clip and that it will not become displaced so as to permit fuze striker to be released.

(c) Refer to applicable rifle operator manuals for grenade launcher and cartridge combinations. Refer to FM 2330 for tactical use of grenade projection adapters with grenades.

(4) *Prepared for use but not launched.* Once safety pin has been removed and safety clip released (where installed), grenade is armed. Launch immediately. Do not attempt to replace safety devices in order to return grenade to safe condition.

d. Adapters, Grenade Projection, M2 Series.

(1) *Applications.* Grenade Projection Adapters M2 Series are designed for adapting cylindrical, chemical hand grenades for projection from rifles equipped with grenade launchers. Two different models are available: the M2 and M2A1 (fig. 2-10). Chemical hand grenades can be projected a maximum of 145 meters when fired from a rifle using Grenade Projection Adapters M2 Series.

(2) *Preparation for use.*

WARNING

Do not use grenade having bent or damaged safety lever with grenade projection adapter. Be sure base of grenade is fully seated against base plate and that each claw holds grenade tightly above base seam. Do not remove safety pin until ready to fire.

(a) *Assure that safety pin is securely in place and that safety lever is not damaged or bent.*

(b) Expand spring of setback band. Place band around grenade with coil spring centered on safety lever 1/2-inch from end of safety lever, as shown in figure 2-10.

(c) Make sure setback band is securely in place on grenade. Then, force grenade into claws until base of grenade is resting on base plate.

(d) Inspect safety lever to see that its end is securely hooked under lug of fuze body.

(3) *Operation.*

WARNING

If setback band fails to hold safety lever securely in place, fire grenade immediately into safe area and take cover.

(a) Holding safety lever in setback band with thumb of one hand, carefully remove safety pin with index finger of free hand.

(b) Slowly remove thumb pressure on safety lever so that it is held in place by setback band and does not move to a position which would permit fuze striker to be released.

(4) Prepared for use but not launched. See c(4) above.

2-4. Rifle Grenade Cartridges

a. *Applications.*

(1) Rifle grenade cartridges (fig. 2-11) are specially designed, bulletless cartridges used for launching rifle grenades from rifles. By use of 2-13 these cartridges, rifles project antitank, high-explosive, fragmentation, illuminating, smoke and chemical grenades; and ground signals. Thus, the range between that which can be reached by throwing a grenade and the minimum range for light mortar fire is covered.

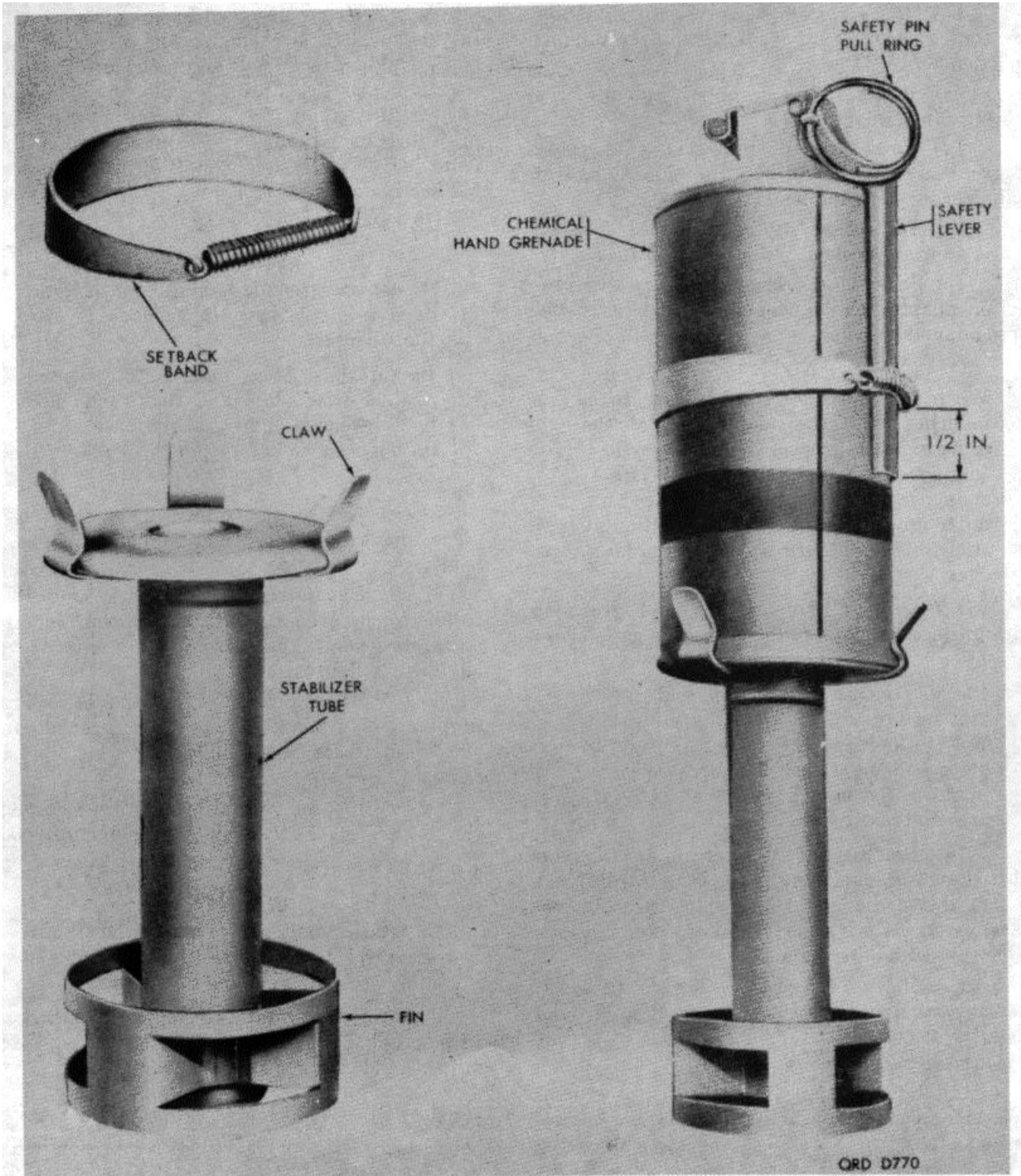
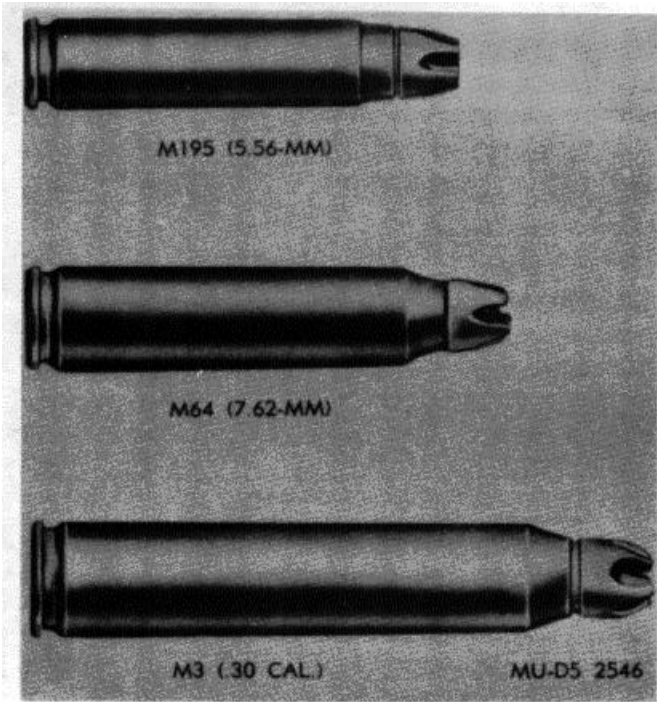

Figure 2-10. Grenade projection adapter M2A1.

Table 2-2. Grenade Cartridge Used with Applicable Rifles

| Rifle model | Caliber | Grenade cartridge model | Grenade launcher, retainer |
|-------------|---------|-------------------------|--|
| M16, M16E1 | 5.66MM | M195 | For grenade launcher and/or retainer, see applicable rifle operator manuals. |
| M14, M14R1 | 7.62MM | M64 | |
| M1 | .30 | M3 | |



NOTE

Grenade Cartridges M6 and M7, found in older packings, are no longer authorized for use. Return to ammunition disposal personnel.

(2) Grenade cartridges used with each rifle are listed in table 2-2.

(3) Rifle grenade cartridges and launcher positioning clips are packed with most rifle grenades and grenade projection adapters. Grenade cartridges are also available for issue packed separately.

b. Precautions.

(1) Use only grenade cartridges prescribed, in firing rifle grenades.

(2) Do not fire rifle grenades with service ammunition (bulleted cartridge) or blank ammunition, under any circumstances.

Section III. OPERATION UNDER UNUSUAL CONDITIONS

2-5. General

The procedure of operation under unusual conditions are similar to those for operation under usual conditions. See paragraph 2-1 and 2-2.

a. Unusual Terrain. Exercise caution when throwing or launching grenades on inclined terrain to prevent rollback of grenade to operator or throwing area.

b. Confined Area. Exercise care in using exploding grenades in confined areas. (High pressure resulting upon detonation may cause collapse of structure. Obstructions may prevent grenades from reaching targets.)

2-6. Extreme Temperature Conditions

a. Protect grenades from snow or ice. (Snow, or ice-covered grenades are difficult to handle.)

b. Clean ice or snow off grenades before use.

CHAPTER 3

MAINTENANCE INSTRUCTIONS

Section 1. SERVICE UPON RECEIPT OF MATERIEL

3-1. General

Upon receipt of materiel, the individual in charge will determine whether the materiel has been properly prepared for service by the supply organization as indicated in this chapter.

3-2. Precautions

Unless packing boxes show evidence of moisture or damage, do not open until grenades are to be issued.

3-3. Unpacking**WARNING**

If hand grenade is packed upside down (fuze down), or right side up (fuze up) with safety pin not in place, do not attempt to remove grenade from its container. Replace packing support or filler material. Replace cover and tape in place. Return container to ammunition disposal personnel.

a. Inspect boxes for damage. If markings on box conflict with nomenclature of grenade type requisitioned, return shipment to ammunition supply personnel. Return boxes with contents showing signs of excessive damage to ammunition supply personnel for disposition.

(1) If applicable, cut steel strapping with shears; twist lock on wooden packing box.

(2) If applicable, cut seal with shears on box hasp.

(3) Open hasp (if applicable) and pry up box cover.

(4) If barrier bag is used, open.

(5) Remove containers from packing box.

(6) Pull off sealing from container end labeled "top". (If metal container, insert key on tab tear strip and turn key.)

(7) Inspect grenades (para. 3-7) before removing.

Figure 3-1. Deleted.

Figure 3-2. Deleted.

Figure 3-3. Deleted.

Change 10 3-2

WARNING

IF THE M76 OR M82 SMOKE GRENADE IS ARMED (SLIDER/ BORERIDER PROJECTING FROM THE BODY, RED SHOWING ON SLIDER), DO NOT ATTEMPT TO REMOVE GRENADE FROM ITS CONTAINER. UNDER NO CIRCUMSTANCES SHOULD ATTEMPTS BE MADE TO RETURN THE SLIDER TO A SAFE POSITION BY HAND. REPLACE PACKING, CLOSE COVER, AND NOTIFY EOD PERSONNEL FOR DISPOSAL.

CAUTION

DO NOT JERK STRAP.

NOTE

Smoke and anti-riot grenade boxes may be packed differently (fig. 3-2). If straps are not used in packing, grenades and spacers must be removed by hand.

(2) Grasp strap loop in hand and pull firmly to remove top grenade/spacer assembly from box (fig. 3-2).

(3) Repeat step 2 to remove lower grenade/spacer assembly.

(4) Salvage spacers and pull straps for reuse.

(5) Salvage ammunition box for reuse.

b. Inspect M76, L96A1 and L97A1 Smoke Grenade metal ammunition box for damage. If markings on box conflict with nomenclature of grenade type requisitioned, return shipment to ammunition supply personnel. Return boxes with contents showing signs of excessive damage to ammunition supply personnel for disposition.

(1) Break seal, unlatch, and open ammunition box cover (fig. 3-3.1).

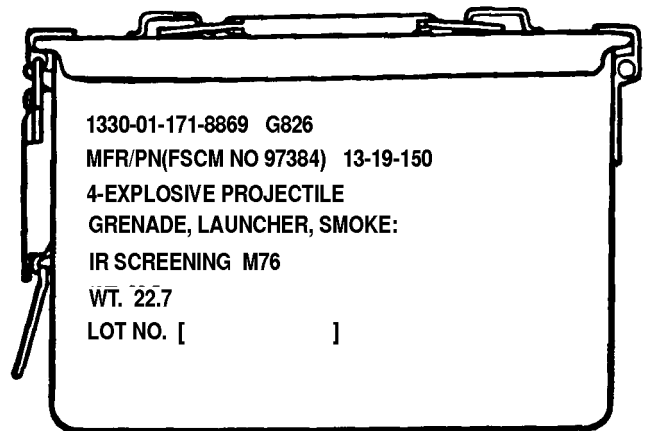

RIGHT SIDE

AR 5767

Figure 3-3.1. Smoke grenade ammunition box.

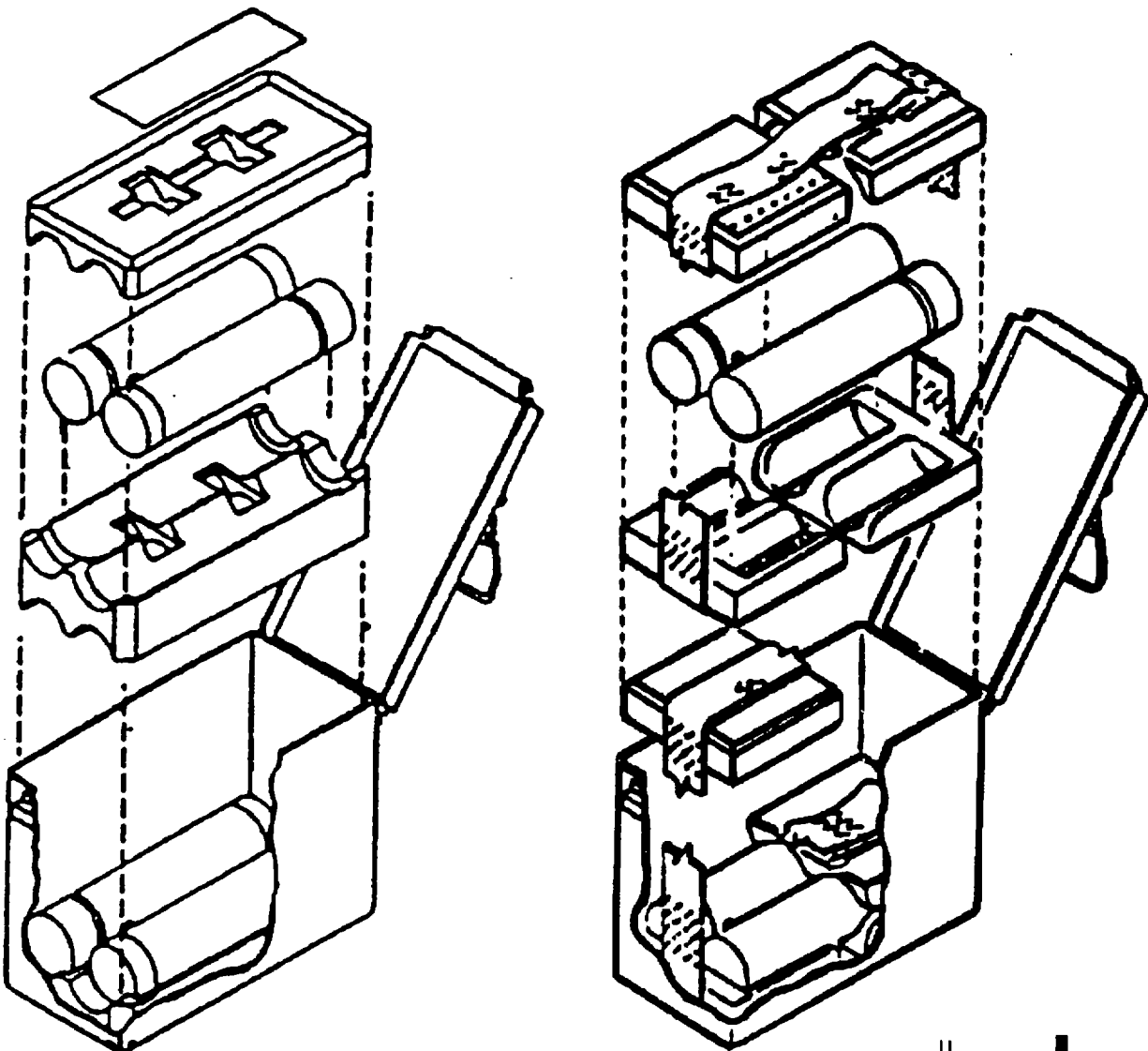

U
AR 5768-A

Figure 3-3.2. IR and simulant grenade boxes and packing.

Section II. TOOLS AND EQUIPMENT

3-4. Common Tools and Equipment

Standard and commonly used tools and equipment having general application to this materiel are authorized for issue by tables of allowances (TA) and tables of organization and equipment (TOE).

3-5. Special Tools and Equipment

Special tools and equipment required at organizational level are listed in appendix C.

Section III. MAINTENANCE-USER/OPERATOR

3-6. General

Maintenance at the user/operator level consists mainly of preventive maintenance. During maintenance, inspect for critical defects. A critical defect is a missing or faulty component of a grenade that may result in hazardous or unsafe conditions for personnel using the grenades.

3-7. Inspection

a. Inspect unpacked hand grenades periodically for the following:

(1) Rust and/or corrosion.

(a) Turn in grenades containing corroded or pitted fuzes and/or safety levers to ammunition disposal personnel.

(b) Turn in grenades with heavily rusted or pitted bodies to ammunition supply personnel for disposition.

(c) Clean grenades with lightly rusted bodies in accordance with paragraph 3-8. Lightly rusted grenade bodies are serviceable and may be thrown or launched from a rifle.

(2) Damaged safety levers or broken lugs (fig. 2-1).

(3) Presence of safety pin. Missing safety pin is a critical defect and ammunition disposal personnel should be notified.

(4) Assure that diamond crimp is present or, if safety pin legs are spread, the spread is 45° to 60°. An insecurely installed safety pin is a critical defect and should be adjusted.

(5) When adjustment of safety pin is required, adjust as follows (fig. 3-4):

(a) *Diamond crimp.* If width between corner points of obtuse angles of diamond crimp is less than 1/16-inch spread safety pin legs to angle of 45° to 60° as shown in figure 3-4.

(b) *Angular spread.* If angular spread is less than 45°, spread safety pin legs to angle of 45° to 60° as shown in figure 3-4.

NOTE

Only one safety pin leg is required to be bent on the M201 series fuzes.

(6) Presence and position of safety clip. The omission of a safety clip on any grenade requiring one is a critical defect and the clip should be installed. (See table 1-1 for listing of grenades requiring safety clips.)

(7) When adjustment or installation of safety clip is required, adjust as follows:

(a) Grenade M67 will be found with two types of safety clips. One type is the same as that used on the M69 (fig. 2-3). The second is adjusted as shown in figure 3-5.

1. Hold the fuzed grenade in palm of hand with pull ring up (1, fig. 3-5).

2. Insert small loop at open end of safety clip in slot of fuze body beneath safety level (2, fig. 3-5).

3. Press clip across safety level until closed end of clip touched safety level and clip has snapped around safety lever (3, fig. 3-5).

(b) Grenade M61 used the same safety clip as the M62. See paragraph 2-1b(2)(g).

(8) Fuze seated and correct assembly of safety clip (when installed) (fig. 3-6).

THIS PAGE INTENTIONALLY LEFT BLANK

U
AR5769

Figure 3-4. Adjustment of safety pin.

(9) Fuze not correctly seated. Fuze should be fully threaded into the grenade body and handtight. Inspect and adjust for correct seating of fuze, as follows:

(a) Hold the fuzed grenade in palm of hand with fuze up (1, fig. 3-6.1).

(b) Turn fuze in a clockwise direction until handtight (2, fig. 3-6.1).

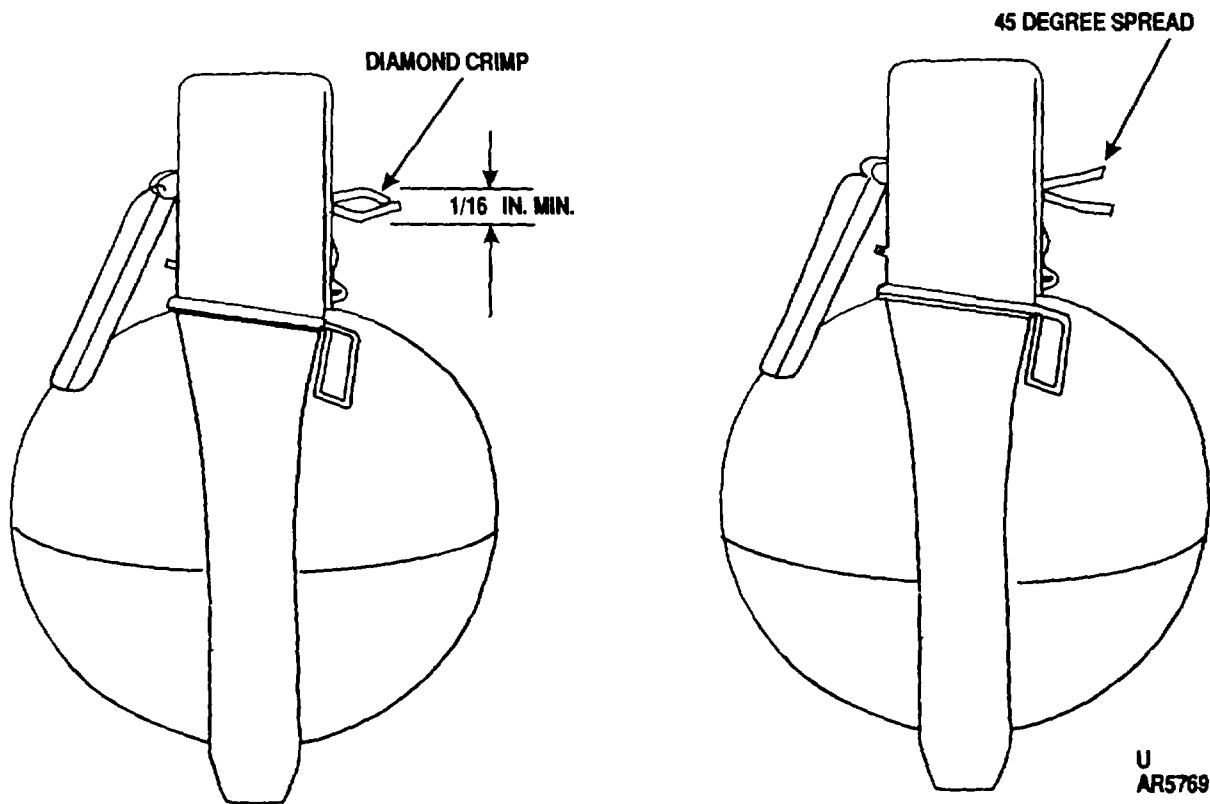
b. Inspect unpacked rifle grenades periodically for the following:

(1) Rust or corrosion on body and stabilizer. Lightly rusted or corroded grenade bodies are serviceable and may be launched. A grenade with any rust or corrosion on the stabilizer is unserviceable and should be turned over to authorized disposal personnel. A grenade with a dented nose projection cap is unserviceable and should be turned over to authorized disposal personnel.

(2) Moisture on inside of stabilizer tube.

(3) Condition of nose protection cap (fig. 3-7).

(4) Presence of safety clip (Rifle Grenades M22 Series) and presence of safety wire (Rifle Grenades M19A1). Absence of these items is a critical defect and ammunition disposal personnel should be notified.

(5) Presence of tape in nose vent (Rifle Grenades M23 Series) and presence of nose closing plug (Rifle Grenades M22 Series).

(6) Dents and deformation in stabilizer tube and fin assembly (fig. 3-8).

c. Inspect unpacked smoke screening grenades, L8A1 and L8A3 periodically. Dispose of grenades containing the following defects:

(1) Metal base punctured.

(2) Rubber body torn or dry rotted.

(3) Electrical contact, corroded or bent.

(4) Metal foil covering gas propulsion holes missing or punctured.

(5) Grenade distortion preventing insertion into launcher (discharger).

d. Inspect unpacked M76 and M82 Smoke Screening Grenades periodically. Dispose of grenades containing the following defects (fig. 1-5b and 1-5c):

(1) Grenade armed, slider/borerider extended, showing red.

(2) Plastic body cracked or damaged.

(3) Electric firing contact clips damaged, bent, corroded, or missing.

(4) Bore seal damaged or missing.

e. Return defective grenades to ammunition disposal personnel for their disposition, except where adjustment is authorized. (See paragraph a(5) above.)

f. Inspect unpacked M90 TA smoke screening grenades periodically. Dispose of grenades containing the following defects (see fig 1-5d).

(1) Damage is noted to the grenade end cop or aluminum body.

(2) Electrical firing contact clips damaged, bent, corroded or missing.

g. Return defective grenades to ammunition disposal personnel for disposition.

h. Inspect unpacked L96A1 and L97A1 anti-riot grenades, periodically. Dispose of grenades containing the following defects:

(1) Damage is noted to grenade's rubber body.

(2) Electrical firing contact clips damaged, bent, corroded or missing.

(3) Plastic propulsion base is cracked or damaged.

i. Return defective grenades to ammunition disposal personnel for disposition.

3-8. Cleaning/Preservation

a. Clean grenades of dirt, mud, grease, sand, etc., taking care not to disturb safety devices, by wiping off with clean, dry cloth or other nonabrasive material (fig. 3-9).

b. Wipe off light rust which can be removed from grenade bodies with clean, dry cloth.

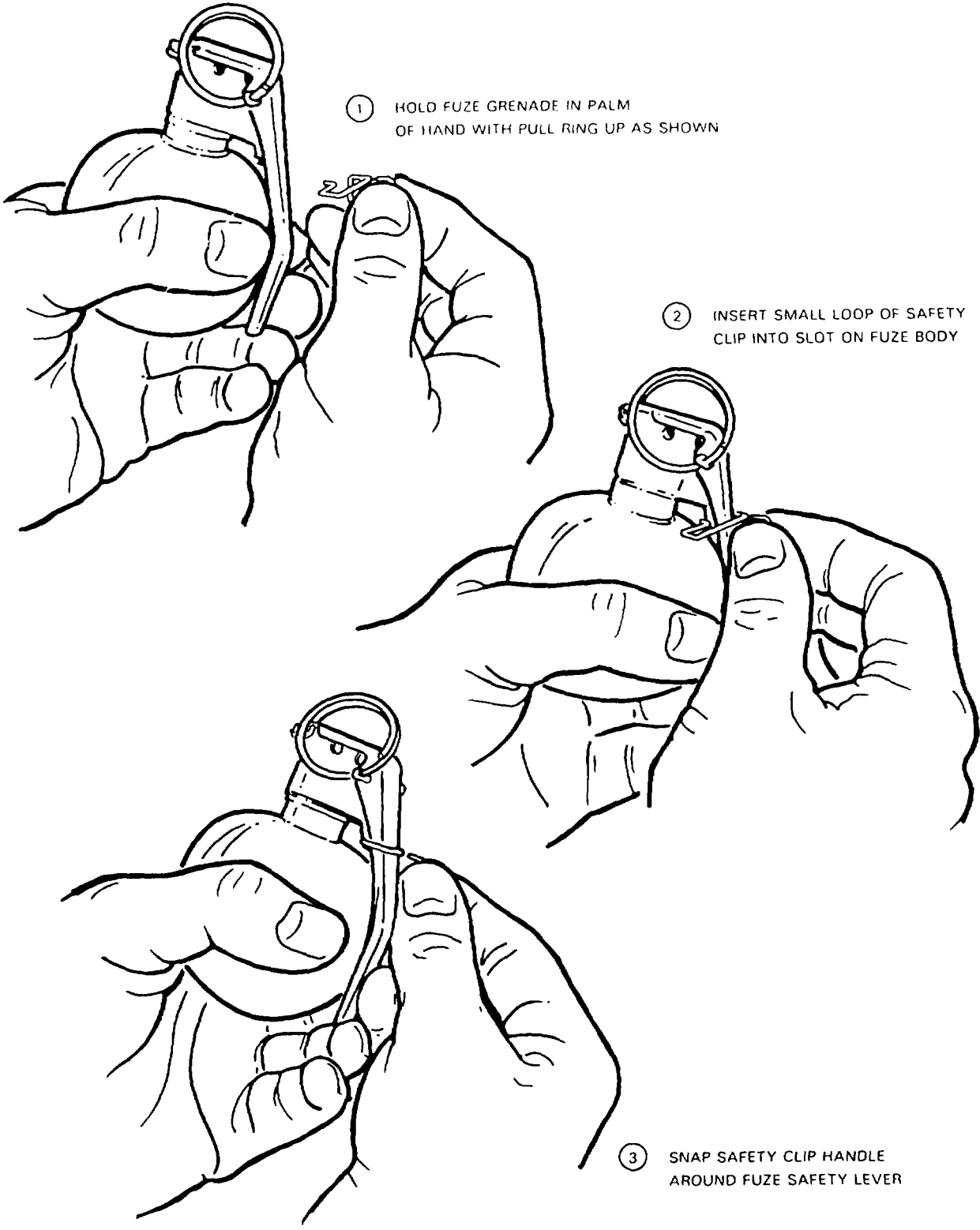

ARD 2658

Figure 3-5. Assembly of safety clip to grenade M67.

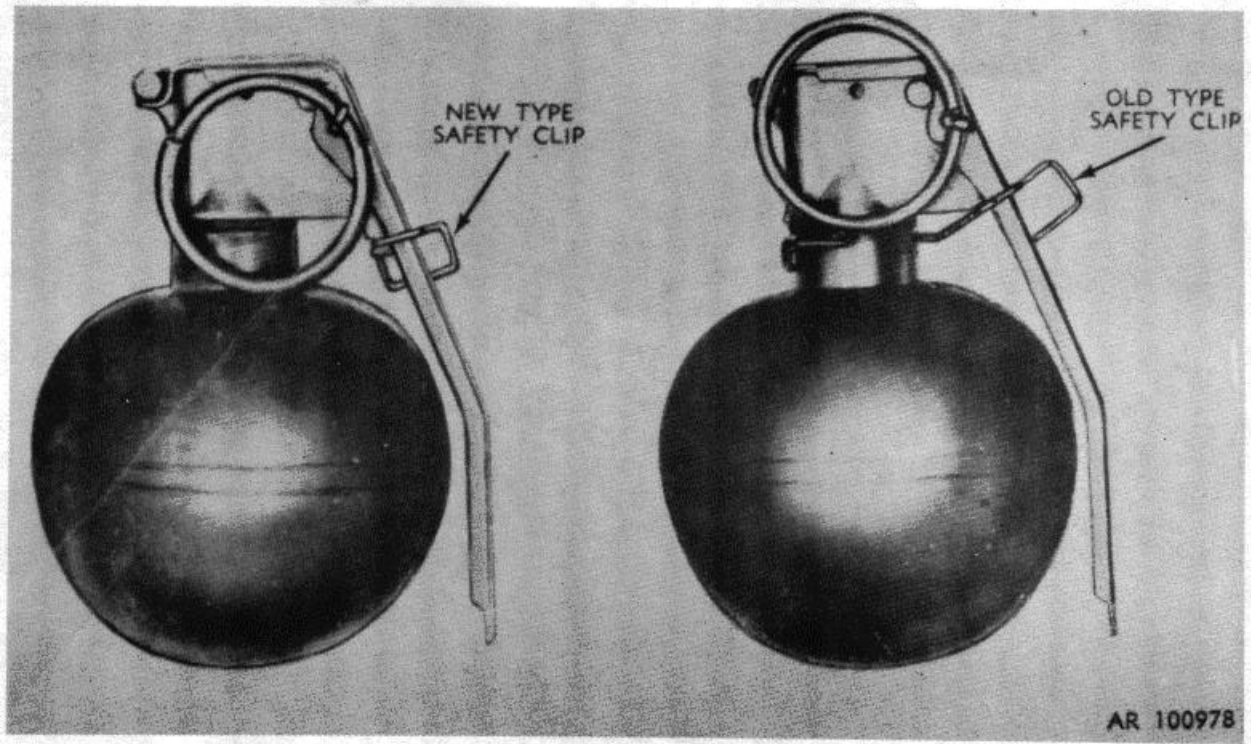

Figure 3-6. Fuze seated w/safety clips.

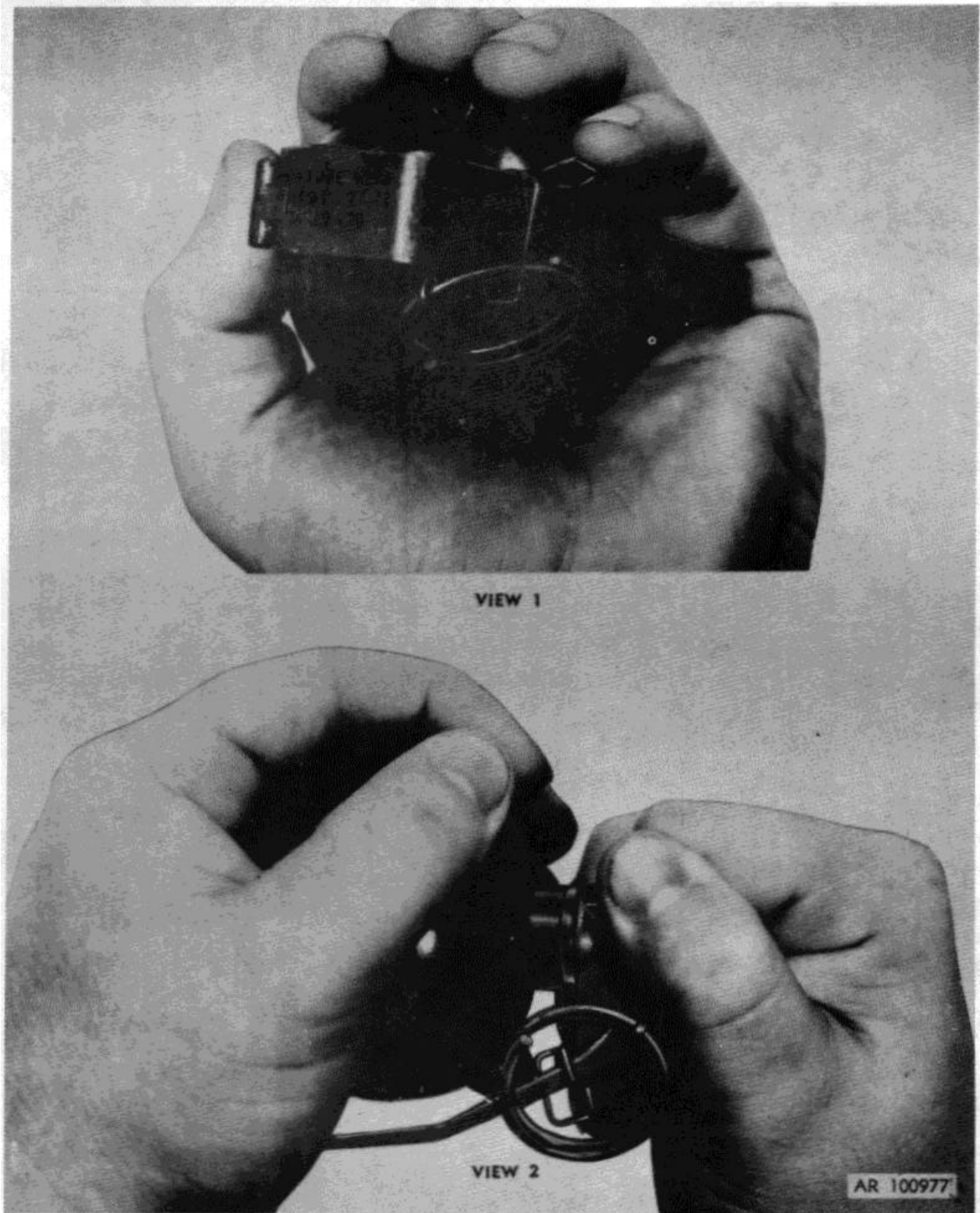

Figure 3-6.1. Tightening fuze to insure correct seating.

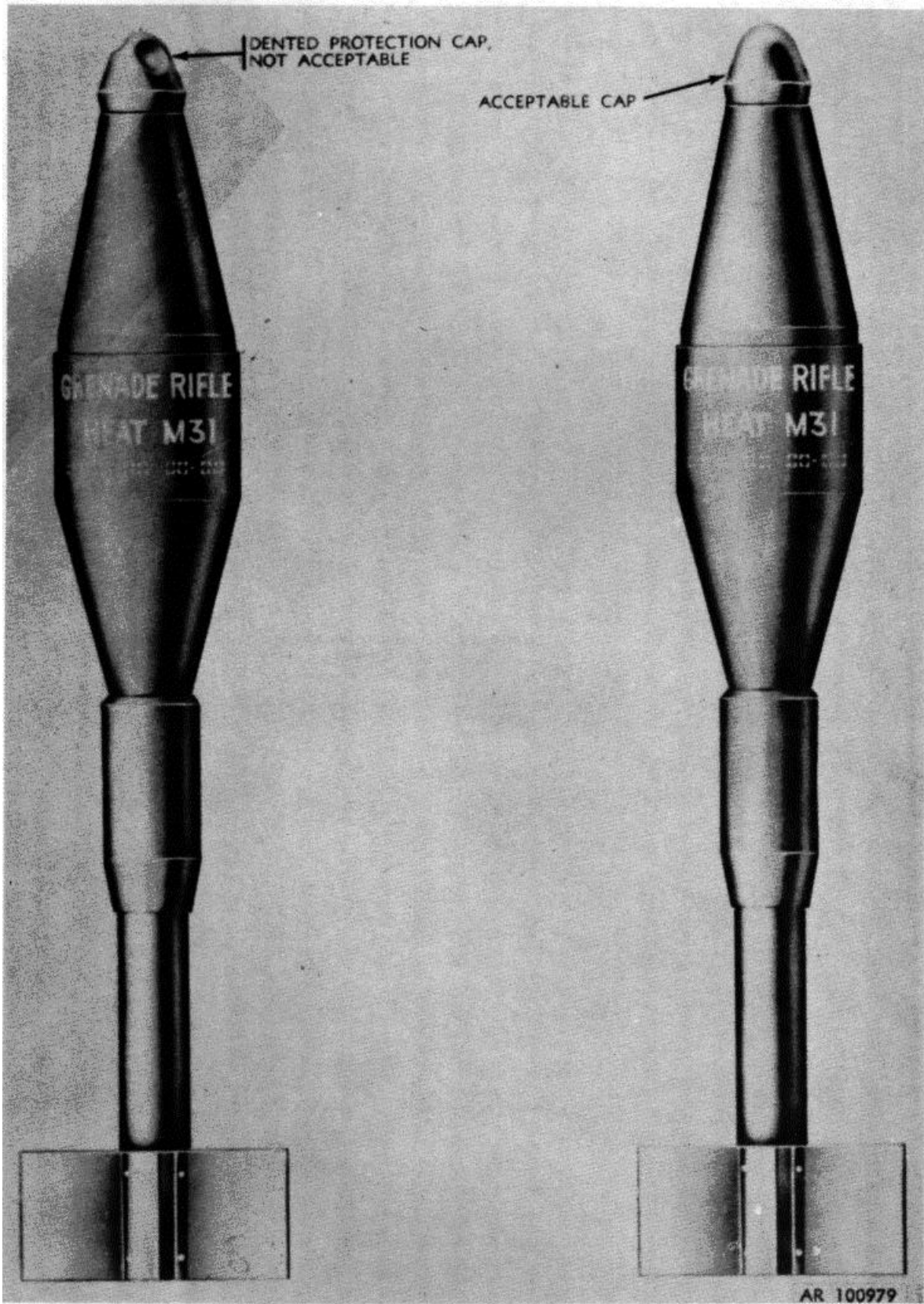

Figure 3-7. Acceptable and dented nose protection caps.

This page intentionally left blank.

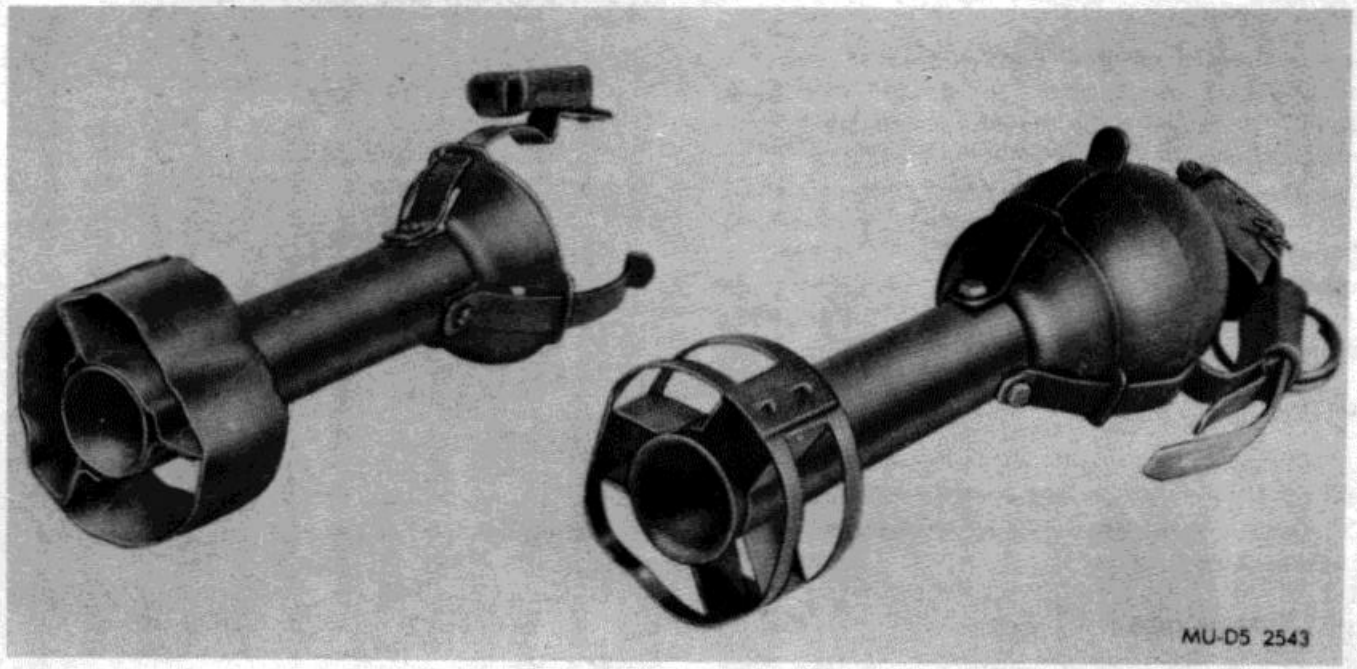

Figure 3-8. Defective stabilizer tube and fin assembly.



Figure 3-9. Cleaning grenades.

Section IV. MAINTENANCE-ORGANIZATIONAL

3-9. General

Organizational maintenance is performed by designated personnel in using units and is primarily preventive in nature. It is performed to prevent deterioration of ammunition due to rough handling and exposure. Direct Support units may be called upon to provide technical advice, assistance, packing materials and expendable supplies for accomplishing maintenance. Direct Support will actually perform the organizational level maintenance if the size of the job to be done exceeds the manpower capability and equipment at organizational level.

3-10. Unpacking

a. For unpacking instructions see Chapter 2, "Preparation For Use" under the appropriate type of grenade.

b. During unpacking, inspect grenades in accordance with paragraph 3-7.

3-11. Inspection

a. Inspect all packing boxes for external damage or moisture .

b. If there is evidence of damage or moisture, unpack and inspect containers for damage or moisture.

c. If containers show evidence of damage or moisture, continue unpacking and inspection, in accordance with paragraphs 3-3 and 3-7, to extent necessary to determine disposition.

d. If lot number of the grenade and fuze is illegible, consider both unserviceable and return to authorized disposal personnel for disposition.

e. If grenade lot number is legible and body color identifiable, but fuze lot number is illegible, grenade may be renovated. Mark and return to higher maintenance echelon for disposition.

3-12. Touch-Up and Spot Painting

Clean grenades as outlined in paragraph 3-8, except that light abrasives may be used to remove rust. Service as follows:

a. Retouch (spot paint) grenade bodies as required to prevent further deterioration. Use same color paint as on grenade body. Re-mark grenade bodies as required to retain proper identity. Use only paints and stencil inks indicated in section III of appendix B.

b. Clean metal ends of fiber or metal container with such materials as sandpaper, wire brushes, emery cloth or steel wool to remove rust from metal. Wipe metal with clean, dry cloth to remove dust prior to repainting. Repaint metal with paint, Black, No. 37038, Spec TT-E-516. Re-mark containers as required to assure proper identity.

c. Re-mark inner packing' by printing, stamping or stenciling as follows to assure proper identity:

(1) *Cartons, bags.* Indicate quantity, nomenclature, lot number, month and year loaded. Mark in 2 -inch wide black letters, No. 37038, Federal Standard 595.

(2) *Metal cans and fiber containers.* Indicate quantity, nomenclature, lot number, month and year loaded. Mark in ½-inch wide white letters, No. 37875, Federal Standard 595 except the metal can for the Grenade, Rifle, Smoke, WP. Mark this can in yellow letters. No. 33538, Federal Standard 595. Table 3-1 indicates marking of sealing strip for fiber containers and alternative cover marking for identifying class of chemical filler other than chemical smoke.

d. Re-mark wood packing boxes on top, one side and both ends in ½ to 1 ½ inch black letters, No. 37038, Federal Standard 595. The following information is required on the box:

Table 3-1. Marking of Sealing Strip and Alternative Cover Marking

| Class of chemical filler | Strip sealing | | Alt banding colors | | No. of Stripes |
|---------------------------------|-------------------|-----------|--------------------|-----------|----------------|
| | Color | Stripes | Color | Stripes | |
| SMOKE (WP) | LIGHT GREEN 14491 | | LIGHT GREEN 34558 | | |
| SMOKE (HC) | LIGHT GREEN 14491 | | LIGHT GREEN 34558 | | |
| GAS HARASSING NON-PERSISTENT | GRAY 16251 | RED 11136 | GRAY 36231 | RED 31136 | 1 |
| GAS HARASSING PERSISTENT | GRAY 16251 | RED 11136 | GRAY 36231 | RED 31136 | 2 |

- (1) Federal Stock Number.
- (2) Department of Defense Identification Code.
- (3) Department of Transportation Classification.
- (4) Gross Weight.
- (5) Cubical Displacement.
- (6) Loaded Data.
- (7) Lot Number.

NOTE

Touchup painting at the organizational level may be accomplished as desired. Use of grenades with light rust and/or corrosion will have no effect on their functioning characteristics.

3-13. Repacking

a. Repacking hand grenades.

(1) Place hand grenades, fuze end up, in containers. Place rifle grenades, nose down, in containers.

(2) If packed in fiber containers, seat one filler on bottom. Insert grenade base end down. Place packing support or filler material over grenade. Use as many fillers on top as required to insure tight packing. Replace container lid or cover, and tape in place (fig. 3-10).

(3) Pack containers in original wooden boxes. If these boxes are not available, approximate original box size and shape.

(a) Grenades packed in fiber containers. Insert containers cover end up into box. Insert end fillers at ends, side fillers along sides, and top fillers on top as required to pack the contents tightly. Add any additional fiber board material necessary to produce a tight packing.

(b) Grenades packed in metal containers. Insert metal containers key end up in box. Place metal containers containing cartridge assortment on central spacer. Place three launcher positioning clips on filler block and secure with one staple. Insert spacer between metal containers and block spacers; add fillers along ends, sides, and top as required to provide tight packing.

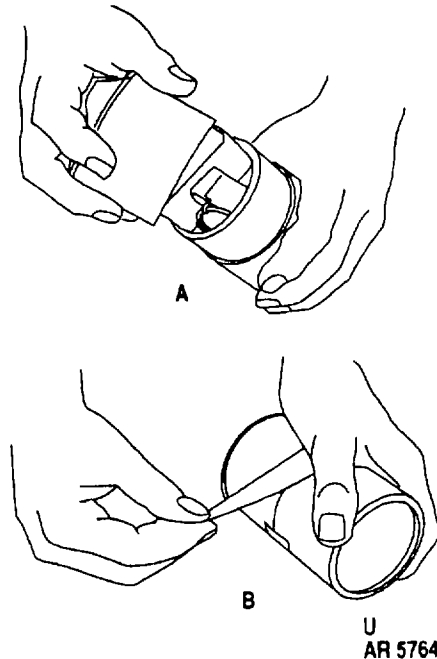

Figure 3-10. Replacement of cover and taping in place.

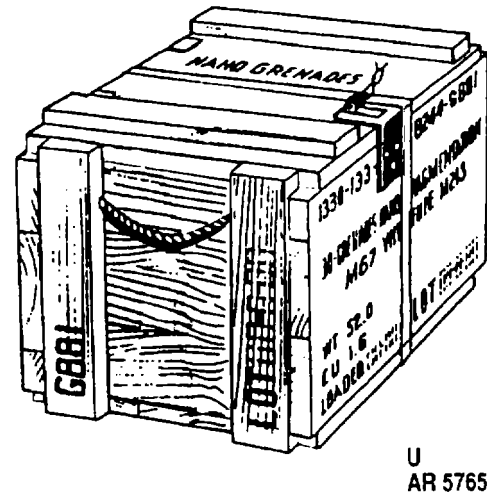

Figure 3-11. Typical outer packing and markings.

(4) Assure box is marked with proper item nomenclature and lot number, as in figure 3-11.

(5) Close box, secure hasp, and band box.

b. Repacking M76 and M82 Smoke Grenades.

NOTE

If strap loops are not contained in the packing, repack the spacers and grenades inside the ammunition box.

Prior to repacking, inspect to assure grenades, box, and packing are serviceable, clean and free of dirt and moisture.

(1) Lay bottom halves of spacer on flat surface (fig. 3-12)

(2) Position a pair of grenades in spacer contours with contact ends facing opposite directions.

(3) Align slider/borerider facing toward the adjacent grenade (fig. 3-12).

(4) Position top halves of spacer on top of grenades.

(5) Assure that slider/borerider is properly aligned.

CAUTION

Slider/Borerider should not be in contact with Space

(6) Loop pull strap lengthwise over the grenade/spacer assembly.

(7) Slide strapped grenade/spacer assembly into ammunition box while holding pull strap taut to prevent twisting or kinking of strap (fig. 3-2).

(8) Assure that strapped grenade/ spacer assembly sits on bottom of box assembly.

(9) Lay strap flat on top of grenade/ spacer assembly; fold if necessary.

(10) Repeat steps 1 through 9 to load second pair of grenades into box.

(11) Close cover, latch, and seal ammunition box.

(12) Close cover, latch, and seal ammunition box.

3-14. Repacking L8A1 Grenades, L8A3 Grenades

a. Place packing and grenades into metal container.

b. Close metal box.

c. Assure box is marked with correct item, nomenclature, and lot number.

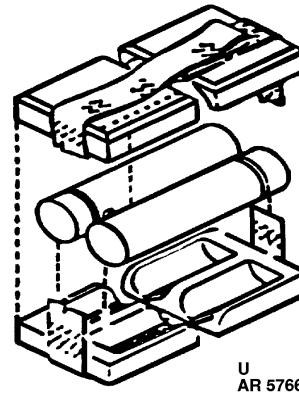

Figure 3-11.1. Grenade/spacer assembly

3-15. Repacking M90 Grenades

NOTE

Prior to repacking, inspect to ensure grenades, box, and packing are serviceable, clean, and free of dents, dirt and moisture.

a. Lay bottom halves of spacer on flat surface (fig 3-11.2).

b. Position a pair of grenades in spacer contours with electric contact ends facing opposite directions.

c. Position top halves of spacer on top of grenades.

d. Repeat steps a through c to load second layer in fig. 3-11.2. The electrical contact ends are positioned opposite those on the grenade below it on the first layer.

e. Close the cover, latch it, and seal the ammunition box.

3-16. Repacking L96A1 and L97A1 Grenades

NOTE

Prior to repacking, inspect to ensure grenades, box, and packing are serviceable, clean, and free of damage, dirt and moisture.

a. Lay bottom half of foam spacer in the bottom of the ammo can with contours facing up (refer to fig 3-3.2).

b. Position a pair of grenades in spacer contours with electric contact ends facing opposite directions.

c. Position top half spacer on top of grenades.

d. Repeat steps a through c to load second layer.

e. Close the cover, latch it, and seal the ammunition.

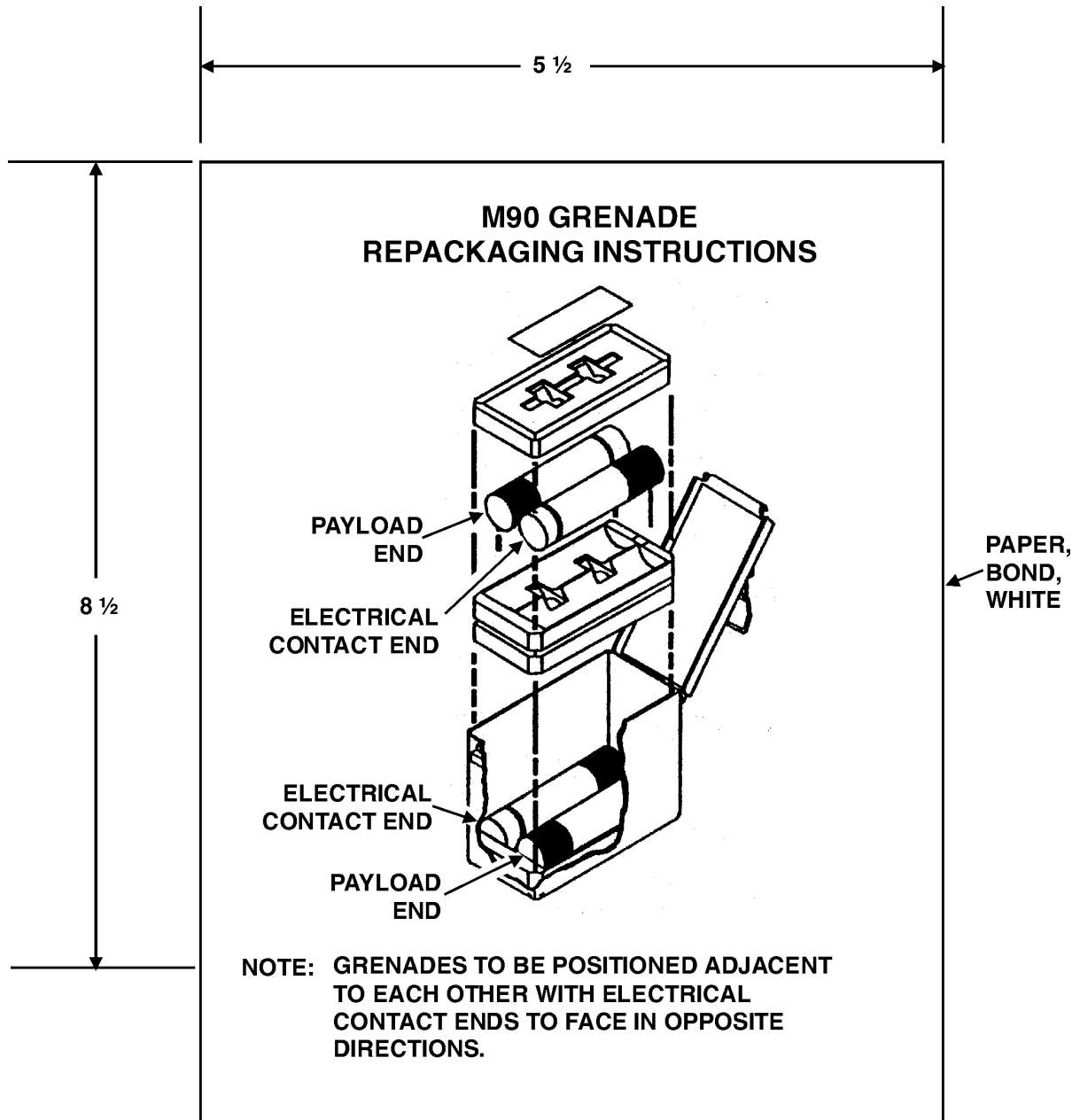

AR 9562

Figure 3-11.2. M90 Grenade/Repackaging Instructions

CHAPTER 4

SHIPMENT AND STORAGE

Section I. SHIPMENT

4-1. Precautions

Give grenades being transported adequate protection. Assure they will not be damaged, contaminated or otherwise degraded so that they become dangerous or their usefulness impaired.

4-2. Instructions

a. *Transportation.*

(1) Block and brace grenade packages being transported in trucks, jeeps and other tactical vehicles. (Blocking and bracing must be adequate to withstand sudden stops and starts, as well as off-road operations.)

(2) If packing is broken or damaged (fig. 4-1) and munitions remain serviceable, restore or replace packing by using acceptable packing material. Assure that all markings (e.g., lot number, nomenclature, FSN, etc.) are transferred to replaced packing.

b. *Handling.*

WARNING

Avoid improper handling as reliability and safety of grenades can be affected and may be hazardous to personnel.

(1) Retain grenades in their packing until issued.

(2) Do not roll, drop, throw or subject grenade boxes to rough handling.

4-3. Data

Data normally appearing on grenade outer pack are illustrated in figure 3-11.

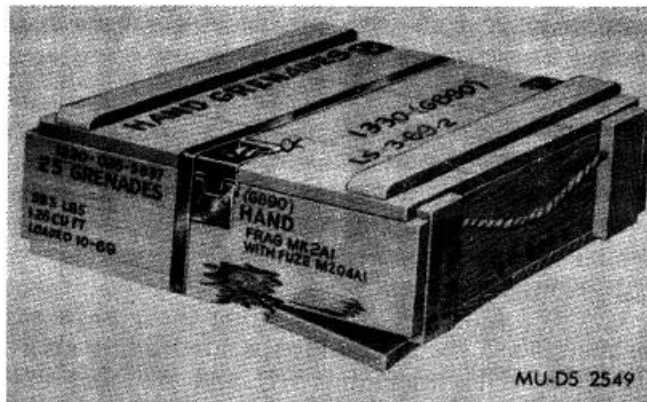

Figure 4-1. Damaged packing box.

Section II. STORAGE

4.4. Precautions

a. Select level, well drained sites free from readily ignitable and flammable materials.

b. Provide nonflammable or fire-resistant overhead covers (e.g., tarpaulin) for all grenades. Maintain overhead space of approximately 18 inches between cover and grenades. Keep cover at least 6 inches from pile on ends and at sides, to permit circulation of air.

c. Temporarily store unserviceable grenades in segregated area.

d. Temporarily store using unit returns in segregated area, for inspection and repacking.

e. Regard suspended grenades as unserviceable, unless otherwise instructed.

4-5. Data

a. *Field Storage Categories.*

(1) *General.* Storage categories are the primary groups into which ammunition is segregated for storage in the field. The groupings are based on consideration of the desirability of storing components of complete rounds in adjacent stacks and on consideration of the hazards of propagation of explosion, range of fragments, spread of fires, and chemical contamination. Safety procedures covering ammunition storage are based on the following factors:

(a) Ammunition items having comparable storage risks are grouped together in the same storage category.

(b) Within each storage category, the maximum quantity of ammunition to be stored within each stack and within each Field Storage Unit (FSU), and the minimum distance between FSU's and the minimum distance between FSU's and categories, are specified in quantity-distance table 4-1 through 4-5 for the storage of ammunition in the field.

(c) Normally, only one kind of ammunition is stored in a stack. Ammunition should be arranged in stacks in the best manner to facilitate inventory and inspection. Where camouflage is a consideration, stacks may be stepped in toward the top (terraced or pyramid stacking) to decrease shadows. Whenever desirable, components of complete rounds may be stored within the same FSU.

(d) Small-arms ammunition, except bulk packed incendiary and tracer cartridges (which must be stored in category D) may be stored with any category.

(2) *Categories for storage of conventional ammunition.* For storage purposes, conventional ammunition is divided into the following categories:

(a) *Category A.* Fixed and semifixed artillery ammunition, except incendiary and chemical.

(b) *Category B.* Propelling charges, fuzes, primers, flash reducers and separate loading artillery projectiles including HE and AP, but excluding incendiary and chemical projectiles.

(c) *Category C.* Mortar ammunition and hand grenades, except incendiary and chemical.

(d) *Category D.* Pyrotechnics and chemical ammunition of all types, including chemical, filled rockets; gas, smoke, and incendiary bombs; gas and smoke artillery ammunition; incendiary and chemical grenades, smoke pots, GB and VX filled mines, and bulk packed incendiary and small-arms tracer cartridges.

(e) *Category E.* All Demolition explosives, antitank and antipersonnel mines (except GB and VX loaded), and components such as blasting caps, firing devices, detonating cord, and safety fuze.

(f) *Category F.* Rockets, rocket motors, and rifle grenades, except chemical.

(g) *Category G.* The following items of Air Force class V supply-all unfuzed high-explosive bombs, aircraft mines, aircraft torpedoes, and fragmentation bombs, fuzes and/or primer-detonators for the above items; and fragmentation bomb clusters, fuzed or unfuzed. The remainder of Air Force class V items must be stored in other applicable categories.

b. Quantity-Distance Tables for Field Storage Categories. Procedures set forth in quantity-distance tables 4-1 through 4-5 are to be used as a guide in the storage of ammunition in the field only. These procedures are based upon the necessities incident to the storage of ammunition in the field. It must be emphasized that any reduction of distances or increase in tonnages to those prescribed increases the probability of loss of life and ammunition.

Table 4-1. Category A, B, or D

| Gross tons per stack | Gross tons per FSU | Minimum distance in feet between | | | |
|----------------------|--------------------|----------------------------------|-------------------|------------------|------------|
| | | Stacks Unbarricaded | Stacks Barricaded | FSU Unbarricaded | Categories |
| Less than 10... | 400 | 40 | 30 | 300 | 750 |
| 10-20 max. | 400 | 50 | 40 | 300 | 750 |

NOTE

If desirable, fixed and semifixed smoke ammunition, except WP., may be stored in category A. The minimum distance between a stack of propelling charges and any other stack must be 100 feet whether barricaded or unbarricaded.

Table 4-2. Category C

| Gross tons per stack | Gross tons per FSU | Minimum distance in feet between | | | |
|----------------------|--------------------|----------------------------------|-------------------|------------------|------------|
| | | Stacks Unbarricaded | Stacks Barricaded | FSU Unbarricaded | Categories |
| Less than 10... | 300 | 75 | 60 | 300 | 900 |
| 10-20 max. | 300 | 105 | 75 | 300 | 900 |

NOTE

Whenever storage space is noted, category C ammunition may be combined with category E.

Table 4-3. Category E

| Gross tons per stack | Gross tons per FSU | Minimum distance in feet between | | | |
|----------------------|--------------------|----------------------------------|-------------------|------------------|------------|
| | | Stacks Unbarricaded | Stacks Barricaded | FSU Unbarricaded | Categories |
| Less than 5... | 50 | 75 | 60 | 300 | 900 |
| 5-10 max. | 50 | 105 | 75 | 300 | 900 |

Table 4-4. Category F

| Gross tons per stack | Stack barricaded & unbarricaded | Minimum distance in feet between | | | |
|---|---------------------------------|----------------------------------|------------------|----------------|------------|
| | | Gross tons Der FSU | FSU unbarricaded | FSU barricaded | Categories |
| The max. allowable gross wt. per stack will be 20 tons. | See note below- | 20 | 200 | 75 | 1500 |
| | | 30 | 230 | 90 | 1500 |
| | | 40 | 265 | 99 | 1500 |
| | | 50 | 295 | 101 | 1500 |
| | | 60 | 330 | 120 | 1500 |
| | | 80 | 390 | 135 | 1500 |
| | | 100 | 455 | 150 | 1500 |

NOTE

The minimum distance between barricaded stacks will be 75 feet. The minimum distance between unbarricaded stacks will be 150 feet.

Table 4-5. Category G Class V

| Gross tons per FSU | Minimum distance in feet between | | |
|--------------------|----------------------------------|----------------|------------|
| | FSU unbarricaded | FSU barricaded | Categories |
| 20 | 200 | 75 | 1500 |
| 30 | 230 | 90 | 1500 |
| 40 | 265 | 99 | 1500 |
| 60 | 299 | 101 | 1500 |
| 60 | 330 | 120 | 1500 |
| 80 | 390 | 135 | 1500 |
| 100 | 455 | 150 | 1500 |

NOTE

Under normal conditions, the Department of the Air Force will store and issue all class V supplies; however, depot commanders should always be prepared to handle these supplies in emergencies.

4-6. Procedures

- a. Use heavy, well supported dunnage to prevent stack from sinking, and to keep bottom tier offground.
- b. Use hardstand of gravel and sand rather than excessive dunnage.

- c. Allow at least 6-inch clearance beneath pile for air circulation.
- d. Dig suitable trenches to prevent water from flowing under pile.

CHAPTER 5 DESTRUCTION OF GRENADES TO PREVENT ENEMY USE

5-1. General

a. Destruction of grenades subject to capture or abandonment will be undertaken by the using arm only when, in the judgment of the unit commander concerned, such action is necessary in accordance with orders of, or policy established by, the Army commander.

b. The information which follows is for guidance only. The conditions under which destruction will be effected are command decisions and may vary in each case, depending upon a number of factors, such as the tactical situation, security classification, the quantity and location of grenades; facilities for accomplishing destruction, and time. In general, destruction of grenades can be accomplished most effectively by burning or detonation, or a combination of these methods. However, selection of the particular method of destruction requires imagination and resourcefulness in the utilization of the facilities at hand under the existing conditions. Time is usually critical.

c. If destruction to prevent enemy use is resorted to, grenades and their components must be so badly damaged that they cannot be restored to a useable condition in the combat zone. Equally important, the same essential components of all grenades must be destroyed so that the enemy cannot assemble complete rounds from undamaged components of several damaged complete rounds.

d. If destruction of grenades is directed, due consideration should be given to the following:

(1) Selection of a site (for the destruction operation) that will cause greatest obstruction to enemy movement and also prevent hazard to friendly troops from fragments incidental to the destruction.

(2) Observance of appropriate safety precautions.

5-2. Methods

Grenades can be most quickly destroyed by burning or detonation. The following methods, in order of preference, are considered the most satisfactory for destruction of grenades to prevent enemy use:

a. *Method No. 1-by Detonation.*

(1) *General.* Packed and unpacked HE grenades, fuzes, and accessories may be destroyed by placing them in piles and detonating them with demolition charges, using 1-pound TNT blocks or equivalent, together with the necessary detonating cord to make up each charge.

(2) *Method of destruction.*

NOTE

One hundred pounds of packed HE grenades require a 2-pound demolition charge to assure complete detonation of the pile. For unpacked HE grenades, a 1-pound demolition charge is sufficient.

(a) Prepare the demolition charge (using the required TNT blocks together with the necessary detonating cord per charge) and place the charges, as necessary, on the pile to be detonated.

(b) Provide for dual priming to minimize the possibility of a misfire. For priming, either a nonelectric blasting cap crimped to at least 5 feet of time blasting fuse or an electric blasting cap and firing wire may be used. Time blasting fuse, which contains black powder, and blasting cap must be protected from moisture at all times.

WARNING

Each roll of fuse must be tested shortly before use. The burning rate of safety fuses varies under different atmospheric and/or climatic conditions; from a burning time of 30 seconds or less per foot to 45 seconds or more per foot.

Time blasting fuse may be ignited by a blasting fuse igniter or an ordinary match; the electric blasting cap requires a blasting machine or equivalent source of electricity.

WARNING

Blasting caps, detonating cord, and time

blasting fuse must be kept separated from the charges until required for use.

NOTE

For the successful execution of methods of destruction involving the use of demolition materials, all personnel concerned will be thoroughly familiar with the provision of FM 5-25. Training and careful planning are essential.

(c) Detonate the charges. If primed with nonelectric blasting cap and time blasting fuse, ignite and take cover; if primed with electric blasting cap, take cover before firing the charges. The danger area for piles detonated in the open is a circular area which varies according to the quantity of explosive items to be destroyed. Quantity-distance data (inhabited building distance) as given in chapter 4 may be used as an appropriate guide for such operations as are contemplated in this chapter.

b. Method No. 2-by Burning.

(1) *General.* Packed and unpacked high-explosive grenades, smoke grenades, and illuminating

grenades may be destroyed quickly and effectively by burning.

(2) *Method of destruction.*

(a) The ammunition should be stacked up in a pile.

(b) Place flammable materials, such as rags, scrap wood, or brush, on and about the pile.

(c) Pour gasoline and oil over the entire pile.

(d) Ignite by means of an incendiary grenade fired from a safe distance, a combustible train of suitable length, or other appropriate means. Take cover immediately. The danger area for piles being burned in the open is 600 meters.

WARNING

Cover must be taken without delay, since an early explosion of explosive ammunition may be caused by the fire. Consideration should be given to the highly flammable nature of gasoline and its vapor. Carelessness in its use may result in painful burns.

APPENDIX A REFERENCES

A.1 SCOPE.

This appendix lists all Army regulations, field manuals, forms, pamphlets, and technical manuals, referenced in this manual. The publication index (DA Pam 25-30) should be consulted frequently for latest changes or revisions of references given in this appendix and for new publications relating to the material covered in this manual.

A.2 ARMY REGULATIONS.

| | |
|---|-------------|
| Reporting of Transportation Discrepancies in Shipments..... | AR 55-38 |
| Malfunctions Involving Ammunition and Explosives | AR 75-1 |
| Accident Reporting and Records..... | AR 385-40 |
| U.S. Army Explosives Safety Program..... | AR 385-64 |
| Identification of Inert Ammunition and Ammunition Components..... | AR 385-65 |
| Reporting of Supply Discrepancies..... | AR 735-11-2 |

A.3 FIELD MANUALS.

| | |
|--|------------|
| NBC Field Handbook..... | FM 3-70 |
| Explosives and Demolitions..... | FM 5-250 |
| Grenades and Pyrotechnic Signals | FM 3-23.30 |

A.4 FORMS.

| | |
|--|--------------|
| Transportation Discrepancy Report..... | SF 361 |
| Report of Discrepancy (ROD)..... | SF 364 |
| U.S. Army Accident Report | DA Form 285 |
| Recommended Changes to Publications and Blank Forms..... | DA Form 2028 |
| Maintenance Request | DA Form 2407 |
| Ammunition Condition Report..... | DA Form 2415 |

TM 9-1330-200-12/TM 1330-12/1A

A.5 PAMPHLETS.

| | |
|--|----------------|
| Consolidated Index of Army Publications and Blank Forms..... | DA Pam 25-30 |
| Ammunition and Explosives Safety Standards | DA Pam 385-64 |
| Functional Users Manual for the Army Maintenance Management System (TAMMS) | DA Pam 738-750 |

A.6 TECHNICAL MANUALS.

| | |
|--|--------------------|
| Storage, Shipment, Handling and Disposal of Chemical Agents and Hazardous Chemicals | TM 3-250 |
| Operator's and Unit Maintenance Manual for Light Vehicle Obscuration Smoke System (LVOSS) | TM 3-1040-286-12&P |
| Operator's and Unit Maintenance Manual for Installation Kit, Grenade Launcher: Adjustable, Multi-Purpose, 66MM, Turret Mounted, M315 | TM 3-1055-649-12&P |
| Organizational Maintenance Manual (Including RPSTL): Launcher, Grenade, Smoke: Screening, RP, M239 | TM 9-1055-642-20&P |
| Ammunition, General..... | TM 9-1300-200 |
| Ammunition Maintenance..... | TM 9-1300-250 |
| Direct Support and General Support Maintenance Manual for Grenades | TM 9-1330-200-34 |
| Army Ammunition Data Sheets for Grenades | TM 43-0001-29 |

**APPENDIX B
MAINTENANCE SUPPLIES**

Section I. INTRODUCTION

B-1. Scope

This appendix lists expendable items which are required for operator and organizational maintenance.

B-2. Explanation of Columns in the Tabular List of Expendable Materials, Section II

a. National Stock No. Column 1 indicates the national stock number assigned to the item and shall be used for requisitioning purposes.

b. Description. Column 2 indicates the Federal item name and the minimum description to identify the item.

c. Specification No. Column 3 indicates the specification which controls the design or characteristics of the item.

d. Unit of Issue. Column 4 indicates the unit of issue of each maintenance supply item.

Section II. EXPENDABLE MATERIALS

NOTE

Materials should be requisitioned through normal supply channels on an as-required basis.

| (1) National stock No. | (2) Description | (3) Specification No. | (4) Unit of issue |
|------------------------------|---|-----------------------------|----------------------------|
| 6810-00-184-4796 | ACETONE: Technical | O-A-51 | gl |
| 8020-00-240-6361 | BRUSH, ARTISTS: flat chisel edge | H-B-118 | ea |
| 8020-00-246-8504 | BRUSH, ARTISTS: round flat edge | H-B-118 | ea |
| 7520-00-223-8000 | BRUSH, STENCIL: 13/16 x 15/16 in | H-B-621 | ea |
| 8020-00-597-4767 | BRUSH, VARNISH: 3/8 in x 5/8 in | H-B-118 | ea |
| 8135-00-579-8457 | CHIPBOARD: 4x8 ft, 0.061-in thk ENAMEL | UU-C-282 | sh |
| 8010-00-297-2122 | Black, No. 37038 | TT-E-516 | gl |
| 8010-00-297-2119 | Blue, light, No. 35109 | TT-E-516 | gl |
| 8010-00-297-2120 | Gray, No. 36231 | TT-E-516 | gl |
| 8010-00-598-5939 | Green, dark, No. 34108 | TT-E-515 | gl |
| 8010-00-828-3193 | Green, light, No. 34558 | TT-E-516 | gl |
| 8010-00-297-2116 | Olive, drab, No. 34087 | TT-E-516 | gl |
| 8010-00-297-2113 | Olive, drab, No. 34087 (5 gl) | TT-E-516 | gl |
| 8010-00-848-9272 | Olive, drab. No. 34087 | TT-E-516 | pt (spray) |
| 8010-00-577-4937 | Red, No. 31168 | TT-E-516 | qt |
| 8010-00-297-2114 | Red, light, No. 31136 | TT-E-516 | gl |
| 8010-00-297-2111 | White, No. 37875 | TT-E-516 | gl |
| 8010-00-878-5761 | White, No. 37875 | TT-E-516 | pt (spray) |
| 8010-00-297-2112 | Yellow, No. 33538 | TT-E-516 | gl |
| 8010-00-844-0870 | Orange, No. 32246 | TT-E-515 | pt |
| | INK, MARKING STENCIL: | | |
| 7510-00-161-0811 | Black, f/porous surface | TT-I-1795 | gl |
| 7510-00-161-0815 | White, f/porous surface | TT-I-1795 | gl |
| 7510-00-161-0812 | Gray, r/porous surface | TT-I-1795 | gl |
| 7510-00-161-0814 | Red, f/porous surface | TT-I-1795 | gl |
| 75100-161-0810 | Green, f/porous surface | TT-I-1795 | gl |
| 7510-00-191-6030 | Black, f/nonporous surface | TT-I-1795 | gl |
| 7510-00-224-6733 | Yellow, f/nonporous surface | TT-I-1795 | pt |

| (1) National stock No. | (2) Description | (3) Specification No. | (4) Unit of issue |
|------------------------------|---|-----------------------------|----------------------------|
| 8010-00-063-8967 | LACQUER: Silver/Aluminum, No. 17178 | MIL-L-1195 | gl |
| 8010-00-063-8968 | Brown, No. 30117 | MIL-L-1195 | gl |
| 8010-00-527-3196 | Lusterless, Sand, No. 30277, f/obliterating stencil markings | TT-L-40 | g] |
| 8010-00-161-7392 | Lusterless, Sand, No. 30277, f/obliterating stencil markings | TT-L-40 | gl (5 gl) |
| 8135-00-754-2628 | PAD, CUSHIONING, SOLID: Pulp 8x4 ft, 1/16-in thk | MIL-B-3106 | ea |
| 5350-00-271-7935 | PAPER, ABRASIVE, FLINT: 2/0, 1/2x6 open coat, gr 1.2.2, class 1 | P-P-105 | pg (100 sh) |
| 8010-00-899-8825 | PRIMER COATING: Zinc chromate, spray | TT-P-1757 | pt |
| 8010-00-515-2208 | PRIMER, PAINT: Zinc chromate | TT-P-666 | gl |
| 7920-00-205-1711 | RAG, WIPING: cotton unbleached, mixture | DDD-R-30 grade 8 | bl (350 lb) |
| 5340-00-598-3442 | SEAL, ANTIPIILFERAGE: 1/2x12 in. | MS-51938-2 | bx (100) |
| 8135-00-239-5291 | SEALS: for 5/8-in strapping | QQ-S-781 | bx (5000) |
| 8135-00-239-5294 | SEALS: for 1/4-in strapping | QQ-S-781 | bx (1000) |
| 6850-00-295-7685 | SILICONE COMPOUND: | MIL-S-8660 | cn (10 lb) |
| 9310-00-240-4737 | STENCILBOARD: oiled, type II, grade III, 18½-in x 181/2 in | UU-S-625 | sh |
| 8135-00-281-4071 | STRAPPING STEEL: 5/8-in | QQ-S781 | co |
| 8135-00-283-0671 | STRAPPING STEEL: 1/4-in | QQ-S-781 | co |
| 7510-00-823-8073 | TAPE, PRESSURE: Black, 1 1/2-in w, type 1 | MIL-T-43036 | ro (60 yd) |
| 7510-00-266-6715 | TAPE, PRESSURE SENSITIVE ADHESIVE: 2-in | PPP-T-60 | ro (72 yd) |
| 8010-00-160-5788 | THINNER: for dope and lacquer | TT-T-266 | cn (5 gl) |
| 8010-00-160-5794 | THINNER, ENAMEL: f/use with alkyd resin enamels | TT-T-306 | gl |
| 8010-00-242-2089 | THINNER, PAINT: Mineral spirits, paint solvent | TT-T-291 | gl |
| 5350-00-242-4405 | WOOL, METALLIC: Steel | FF-S-740 | ro (1 lb) |

APPENDIX C

MAINTENANCE ALLOCATION CHART (MAC)

Section I. INTRODUCTION

C-1. General

a. The MAC assigns authorized maintenance functions to each maintenance category. Maintenance functions are assigned to the lowest maintenance category, as warranted by past experience in the following considerations:

- (1) Skills available.
- (2) Man hours available vs. Maintenance function manhour requirements.
- (3) Tools and test equipment authorized.

b. The basic entries on the chart list functional groups applicable to the end items which may require maintenance parts. The term functional group applies to assemblies and subassemblies but not to piece parts. Entries are brief, general descriptions without stock or part numbers, in order to minimize need for subsequent change; however, entries permit positive identification.

C-2. Maintenance Functions

Maintenance functions are limited to and defined as follows:

a. *INSPECT*. To determine serviceability of an item by comparing its physical, and mechanical characteristics with established standards.

b. *TEST*. To verify serviceability and to detect mechanical failure by use of test equipment.

c. *SERVICE*. To clean and to preserve. If it is desired that elements, such as painting and lubricating, be defined separately, they may be so listed.

d. *ADJUST*. To rectify to the extent necessary to bring into proper operating range.

e. *ALIGN*. To adjust specified variable elements of an item to bring to optimum performance.

f. *CALIBRATE*. To determine corrections to be made in readings of instruments or test equipment used in precise measurement. Consists of comparison of two instruments, one of which is a certified standard of

known accuracy, to detect and adjust any discrepancy in accuracy of the instrument being compared with the certified standard.

g. *INSTALL*. To remove and replace unserviceable parts or components.

h. *REPLACE*. To replace unserviceable items with serviceable assemblies, subassemblies, or parts.

i. *REPAIR*. To restore an item to serviceable condition through correction of a specific failure or unserviceable condition.

j. *OVERHAUL*. To restore an item to a completely serviceable condition as prescribed by maintenance serviceability standards.

k. *REBUILD*. To restore an item, as nearly as possible, to original or new condition: in appearance, performance and life expectancy. This is accomplished through the maintenance technique of complete disassembly of the item, inspection of all parts or components, replacement of unserviceable elements, and subsequent reassembly of the item.

l. *SYMBOLS*. The uppercase letter placed in the appropriate column indicates the lowest level at which that particular maintenance function is to be performed.

C-3. Explanation of Format

Purpose and use of the format are as follows:

a. *Column 1, Group number*. Column 1 lists group numbers, the purpose of which is to identify components, assemblies, subassemblies and modules with the next higher assembly.

b. *Column 2, Functional group*. Column 2 lists the noun names of components, assemblies, subassemblies and modules on which maintenance is authorized.

- c. *Column 3, Maintenance functions.*
- d. *Use of symbols.*
- e. *Column 4, Tools and equipment.* This column

will be used to specify, by code, those tools and test equipment required to perform the designated function.

- f. *Column 5, Remarks.* Self-explanatory.

**Maintenance Allocation Chart
Grenades, Hand: Fragmentation, M61, M26A1, M26, Mk2**

| (1) G R O U P N U M B E R | (2) CAD/PAD Functional group | (3) Maintenance functions | | | | | | | | | | | (4) Tools and equipment | (5)* Remarks | |
|--|--|---------------------------------|------------------|---------------------------------|----------------------------|-----------------------|---------------------------------|------------------|---------------------------------|----------------------------|--------------------------------------|----------------------------|-------------------------------|-----------------|---------------------------------|
| | | I N S P E C T | T E S T | S E R V I C E | | | | | I N S T A L L | A D J U S T | R E N O V A T E | | | | |
| | | | | U N P A C K | R E P A C K | C L E A N | T O U C H U P | M A R K | | | P A I N T | R E P A I R | | | R E P L A C E |
| 1 | Grenade, Hand: Fragmentation, w/Fuze (See Above) | C | D | O | O | C | O | O | | H | F | | | 1, 2, 3 | a, b, c |
| 2 | Packing Material | O | | O | O | O | O | O | | - | | O | O | 1, 2,3 | a, b, c b, c |
| 3 | Fuze M2O4A1 | H | D | H | H | H | | | | | | | | | |
| 4 | M2O4A2 | | | | | | | | | | | | | | |
| 5 | Safety Pin w/Pull Ring | C | | | | | | | C | C | C | | | None req'd | d |
| 6 | Safety Clip | H | | | | | | | H | H | | | | None req'd | g |
| 6 | FIBERGLASS SLEEVE | H | | H | H | | | | H | H | | | | | |

**Maintenance Allocation Chart-Continued
Grenades, Hand: Fragmentation, M67, M33, M68, M59, (M3\$ w/Fuze, M217), M57,
M26A2 (Impact Fuzed)**

| (1) G R O U P N U M B E R | (2) CAD/PAD Functional group | (3) Maintenance functions | | | | | | | | | | | (4) Tools and equipment | (5)* Remarks | |
|--|--|---------------------------------|------------------|---------------------------------|----------------------------|-----------------------|---------------------------------|------------------|---------------------------------|----------------------------|--------------------------------------|----------------------------|-------------------------------|-----------------|---------------------------------|
| | | I N S P E C T | T E S T | S E R V I C E | | | | | I N S T A L L | A D J U S T | R E N O V A T E | | | | |
| | | | | U N P A C K | R E P A C K | C L E A N | T O U C H U P | M A R K | | | P A I N T | R E P A I R | | | R E P L A C E |
| 1 | Grenade, Hand: Fragmentation, w/Fuze (See Above) | C | D | O | O | C | O | O | . | C | F | D | | 1, 2, 3 | a, b, c |
| 2 | Packing Material | O | | O | O | O | O | | | | | O | O | 1, 2, 3 | a, b, c e f |
| 3 | Fuze M213 | D | D | D | D | | | | D | | | | | | |
| 4 | Fuze M217 | D | D | D | D | | | | D | | | | | | |
| 5 | Safety Pin w/Pull Ring | C | | | | | | | C | C | | | | | |
| 6 | Safety Clip | C | | C | C | | | | C | C | | | | | |

Maintenance Allocation Chart-Continued
Grenades Hand: M7, M7A1, ABC-M7A2, ABC-M7AS, M18, M15, AN-M8, M54

| (1) G R O U P N U M B E R | (2) CAD/PAD Functional group | (3) Maintenance functions | | | | | | | | | | | (4) Tools and equipment | (5)* Remarks | |
|--|---|---------------------------------|------------------|---------------------------------|----------------------------|-----------------------|---------------------------------|------------------|---------------------------------|----------------------------|--------------------------------------|----------------------------|-------------------------------|-----------------|---|
| | | I N S P E C T | T E S T | S E R V I C E | | | | | I N S T A L L | A D J U S T | R E N O V A T E | | | | |
| | | | | U N P A C K | R E P A C K | C L E A N | T O U C H U P | M A R K | | | P A I N T | R E P A I R | | | R E P L A C E |
| 1 2 3 4 5 | Grenade, Hand: Packing Material Fuze, M206 Series, M226, M201A1 Safety Pin and Pull Ring Safety Pin | C O H C F | D D | O O H F | O O H F | C O H F | O O H | O O H | | H C F | F H | O O | O O | 1,2,3 1,2,3 | a, b, c, p a, b, c, p p p p |

Maintenance Allocation Chart-Continued
Grenades, Hand: ABC-M25A1, ABC-M25A2, MS4, AN-M14, XM58

| (1) G R O U P N U M B E R | (2) CAD/PAD Functional group | (3) Maintenance functions | | | | | | | | | | | (4) Tools and equipment | (5)* Remarks | |
|--|--|---------------------------------|------------------|---------------------------------|----------------------------|-----------------------|---------------------------------|------------------|---------------------------------|----------------------------|--------------------------------------|----------------------------|-------------------------------|-----------------|---------------------------------|
| | | I N S P E C T | T E S T | S E R V I C E | | | | | I N S T A L L | A D J U S T | R E N O V A T E | | | | |
| | | | | U N P A C K | R E P A C K | C L E A N | T O U C H U P | M A R K | | | P A I N T | R E P A I R | | | R E P L A C E |
| 1 2 4 3 | Grenade, Hand: w/Fuze (See Above) Packing Material Safety Pin and Pull Ring Safety Pin and Pull Ring | C O C C | D C | O C C | O O | C O | O O | O O | | H C | F F | O O | O O | 1, 2, 3 | a, b, c |

Maintenance Allocation Chart - Continued
Grenade, Hand: Offensive, Mk3A2

| (1) Group No. | (2) Functional Group | (3) | | | | | | | | | | | (4) Tools and Equipment | (5) Remarks | |
|------------------|-----------------------------------|---------|----------------------|---------|--------|-------|----------|------|---------|--------|----------|--------|----------------------------|----------------|---------|
| | | Inspect | Maintenance Function | | | | | | | | | | | | |
| | | | Test | Service | | | | | Install | Adjust | Renovate | | | | |
| | | | | Unpack | Repack | Clean | Touch up | Mark | | | Paint | Repair | | | Replace |
| 1 | Grenade, Hand: Offensive w/Fuze | C | D | 0 | 0 | C | - | 0 | - | H | - | - | - | 1,2,3 | a,b,c |
| 2 | Packing Material | 0 | - | 0 | 0 | 0 | 0 | 0 | - | - | - | 0 | 0 | 1,2,3 | a,b,c |
| 3 | Fuze, M206A2 | C | D | C | C | C | - | - | C | C | - | - | - | | h i |
| | | C | D | F | F | F | - | - | F | F | - | - | - | | |
| 4 | Safety Pin w/Pull Ring | C | - | - | - | - | - | - | - | C | | | | | |
| 5 | Safety Clip | C | - | C | C | - | - | - | C | C | - | - | - | | h i |
| | | F | - | F | F | - | - | - | F | F | - | - | - | | |
| 6 | Grenade, Hand Offensive, w/o Fuze | 0 | - | 0 | 0 | 0 | - | 0 | - | - | | | | 1,2,3 | a,b,c |

Maintenance Allocation Chart - Continued
Grenade, Hand: Practice, M30, M62 and M69

| (1) Group No. | (2) Functional Group | (3) | | | | | | | | | | | (4) Tools and Equipment | (5) Remarks | |
|------------------|--|---------|----------------------|---------|--------|-------|----------|------|---------|--------|----------|--------|----------------------------|----------------|---------|
| | | Inspect | Maintenance Function | | | | | | | | | | | | |
| | | | Test | Service | | | | | Install | Adjust | Renovate | | | | |
| | | | | Unpack | Repack | Clean | Touch up | Mark | | | Paint | Repair | | | Replace |
| 1 | Grenade, Hand: Practice, M30, M62, M69 w/Fuzes | C | - | C | 0 | C | 0 | Q | - | - | F | - | - | 1, 2, 3 | a, b, c |
| 2 | Packing Material | 0 | - | 0 | 0 | 0 | 0 | 0 | - | - | - | 0 | 0 | 1, 2, 3 | a, b, c |
| 3 | Fuze, M205A1 and M205A2 | C | D | C | 0 | C | - | - | C | - | - | - | 0 | 1, 2, 3 | |
| 4 | Body, M30, M62, M69 | C | - | C | 0 | C | 0 | 0 | - | - | F | | | 1, 2, 3 | a, b, c |
| 5 | Plastic Stopper | C | - | C | 0 | 0 | - | - | C | - | - | - | C | 1, 2, 3 | a, j, k |
| 6 | Charge, Practice | C | - | C | 0 | - | - | - | C | - | - | - | C | 1, 2, 3 | a, j, k |
| 7 | Safety Clip | C | - | C | 0 | - | - | - | C | - | - | - | C | 1, 2, 3 | a, l |
| | Safety Pin w/Pull Clip | C | - | - | - | - | - | - | C | - | - | - | | | |
| | Fuze, M228 | C | D | C | 0 | C | - | - | C | - | - | - | C | 1, 2, 3 | a, m |

Maintenance Allocation Chart - Continued
Special Types

| (1) Group No. | (2) Functional Group | (3) | | | | | | | | | | | (4) Tools and Equipment | (5) Remarks | |
|------------------|--|---------|----------------------|---------|--------|-------|----------|------|---------|--------|----------|--------|----------------------------|----------------|---------|
| | | Inspect | Maintenance Function | | | | | | | | | | | | |
| | | | Test | Service | | | | | Install | Adjust | Renovate | | | | |
| | | | | Unpack | Repack | Clean | Touch up | Mark | | | Paint | Repair | | | Replace |
| 1 | Grenade, Launcher, Smoke: Screening, RP, UK L8A1, L8A3 | C | - | C | C | C | F | F | - | - | - | - | - | | |
| 2 | Grenade, Launcher, Smoke: IR Screening, M76 | C | - | C | C | C | F | F | - | - | - | - | - | | |
| 3 | Grenade, Launcher, Smoke: Simulant Screening, M82 | C | - | C | C | C | F | F | - | - | - | - | - | | |
| 4 | Grenade, Launcher, Smoke: Screening, TA, M90 | C | - | C | C | C | F | F | - | - | - | - | - | | |
| 5 | Grenade, Discharger: Anti-Riot, Irritant, CS, L96A1 | C | - | C | C | C | F | F | - | - | - | - | - | | |
| 6 | Grenade, Discharger, Anti-Riot, Practice, L97A1 | C | - | C | C | C | F | F | - | - | - | - | - | | |

| | |
|--|---|
| <p><i>Legends:</i></p> <p>C - User/operator O - Organizational maintenance F - Direct support maintenance. H - General support maintenance. D - Depot maintenance.</p> | <p><i>Remarks:</i></p> <p>a. Explanation of numbers - refer to Special Tools and Equipment List. b. For strapping grenade boxes, use 3/8-inch wide strapping. If not available, 5/8-inch wide strapping may be used. c. For palletizing, use 1-1/4 inch wide strapping. d. For use on Hand Grenade, M61. e. For use on Hand Grenades, M67 and M33. f. For use on Hand Grenades, M68, M59 (33A1 w/Fuze, M217), M57 and M26A2. g. Not applicable to Grenade, Mk2. h. Applicable to Navy. i. Applicable to Army. j. For Practice Grenades, M30 and M62, the use of practice charges and stoppers is optional. k. Do not use practice charges or stoppers with Grenade, M69. l. For Practice Grenades, M62 and M69. m. For use on Practice Grenades, M69. n. No test Rifle Grenade HEAT, M31 is authorized at any maintenance level. o. Installation of these devices is only authorized in event of aborted firing mission. p. If the inner pack for the grenade is a metal case, these operations do not apply. q. Packed in fiberboard container. r. Packed in metal container.</p> |
|--|---|

Maintenance Allocation Chart - Continued
 Grenade, Hand: Non-Lethal (Stun), M84

| (1) Group No. | (2) Functional Group | (3) | | | | | | | | | | | (4) Tools and Equip- ment | (5) Remarks | |
|---------------------|---|---------|----------------------|---------|--------|-------|----------|------|---------|--------|----------|--------|---------------------------------------|----------------|---------|
| | | Inspect | Maintenance Function | | | | | | | | | | | | |
| | | | Test | Service | | | | | Install | Adjust | Renovate | | | | |
| | | | | Unpack | Repack | Clean | Touch up | Mark | | | Paint | Repair | | | Replace |
| 1 | Grenade, Hand: Non-Lethal (Stun), M84 | C | D | O | O | C | O | O | - | H | - | - | - | 1, 2, 3 | a, b, c |
| 2 | Packing Material | O | - | O | O | O | O | O | - | - | - | O | O | 1, 2, 3 | a, b, c |
| 3 | Safety Pin w/Pull Ring | C | - | - | - | - | - | - | - | C | - | - | - | | |
| 4 | Secondary Safety w/Triangular Pull Ring | C | - | - | - | - | - | - | - | C | - | - | - | | |

Repair Parts List

| Item which uses repair part | Repair part NSN | Description repair part |
|--|--|---|
| Grenade Hand, Practice: M62 | 1330-00-308-5655 | Body, Practice, Hand Grenade, M30 w/Washer & Stopper, Unassembled |
| Grenade, Hand, Practice: M62 | 1330-00-028-5851 | Fuze, Hand Grenade, M205A2 |
| Grenade, Hand, Practice: M62 | 1330-G914* | Charge, Practice, Hand Grenade |
| Grenade, Hand, Practice: M62 | 1330-00-935-6149 | Clip, Safety, Grenade, Hand |
| Grenade, Hand, Practice: M69 | 1330-00-178-8515 1330-00-133-9276 | Body, Practice, Hand Grenade, M69 Fuze, Hand Grenade, M228 w/Safety Clip Unassembled |
| Grenade, Hand, Colored Smoke, M18, Green, Red, Yellow, Violet (Applicable to all of above colors) | 8140-00-345-9022 | Grenade, Packing Assembly |
| Grenade, Hand, Fragmentation, Mk2; Practice, M21 | 8140-00-824-0819 8140-00-827-6247 | Container, Ammunition Fiber, M41A2 Box, Packing, Assembly |
| Grenade, Hand, Offensive, Mk3A2 | 8140-00-152-0009 | Box, Packing, Ammunition |
| Grenade, Hand, Fragmentation, M26 Series, M57, M61; Practice, M30 | 8140-00-859-8019 8140-00-861-2101 8140-00-857-2919 | Container, Ammunition, Fiber, M289A2 Support, Container Box, Packing, Ammunition |
| Grenade, Hand, Incendiary, TH3, AN-M14 | 8140-00-345-9022 | Grenade, Packing Assembly |
| Grenade, Hand, Riot, CS, M7A2; Riot, CN, M7A1, Riot CN1, ABC-M25A2, Smoke, AN-M8, Smoke, TA, Practice, M83 | 8140-00-345-9022 | Grenade, Packing Assembly |
| Grenade, Rifle, HEAT, M31 | 8140-00-828-0817 8140-00-828-7417 | Container, Assembly, Rifle Grenade, Fiber, M354A2 Box, Packing, Assembly |
| Grenade, Rifle, AT, Practice, M29 | 8140-00-828-7425 | Box, Packing, Ammunition |

* Department of Defense Ammunition Code indicated in lieu of NSN since each variation of packaging requires a different NSN.

C-4. Special Tools and Equipment

Explanation of Columns.

(1) Column 1 indicates the item number.

(2) *Source, Maintenance, and Recoverability (SMR) code - Column 2.*

(a) Source code indicates the selection status and source for the listed item.

| <i>Code</i> | <i>Explanation</i> |
|-------------|--|
| P----- | Equipment supplied from GSA/DSA or Army Supply System. |

(b) Maintenance codes indicate the lowest category of maintenance authorized to install the listed item.

| <i>Code</i> | <i>Explanation</i> |
|-------------|----------------------------|
| C----- | Operator/crew |
| O----- | Organizational maintenance |
| F----- | Direct support maintenance |

(c) Recoverability code indicates whether unserviceable items should be returned for recovery or salvage. Items not coded are expendable

| <i>Code</i> | <i>Explanation</i> |
|-------------|---|
| R | Item considered economically repairable at direct and general support maintenance levels. When the item is no longer economically repairable, it is normally disposed of at GS level. |

(3) *National Stock Number(NSN). Column 3.* This column indicates the NSN assigned to the item and will be used for requisitioning purposes.

(4) *Description. Column 4.* This column indicates the Federal item name and any additional description of the item repaired.

(5) *Unit of Measure (U/M). Column 5.* A 2-character alphabetic abbreviation indicating the amount of quantity of the item upon which the allowances are based (e.g., ft, ea, pr, etc.).

Special Tools and Equipment

| Item No | SMR code | National stock number (NSN) | Description | Unit of issue |
|---------|----------|-----------------------------|---|---------------|
| 1 | PO-- | 3540-00-565-6242 | STEEL STRAPPING and SEALING KIT: 5/8" W X 0.023" thk strap. | ea |
| 2 | PO-- | 3540-00-565-6244 | STEEL STRAPPING and SEALING KIT: 1 1/4" W X 0.035" thk strap. | ea |
| 3 | POR | 7490-00-164-0537 | STENCIL CUTTING MACHINE; HAND OPERATED. | ea |

By Order Of the Secretaries Of the Army and the Navy:

Official:

VERNE L. BOWERS,
*Major General, United States Army,
The Adjutant General.*

W. C. WESTMORELAND,
*General, United States Army,
Chief of Staff.*

MARK W. WOODS
*Rear Admiral, United States Navy
Commander
Naval Ordnance Systems Command*

M. H. FORWARD
Acting Quartermaster General Of the Marine Corps

Distribution:

Army:

To be distributed in accordance with DA Form 12-40, (qty rqr block No. 333) Organizational maintenance requirements for Grenades.

Marine Corps:

MARCORPS LIST 'E/BE' Copy to 700158 (3) 700161 (2)

RECOMMENDED CHANGES TO EQUIPMENT TECHNICAL PUBLICATIONS

| | | | |
|--|------------|--|-------------------|
|  <p style="font-size: small; margin: 0;"><i>THEN...JOT DOWN THE DOPE ABOUT IT ON THIS FORM. CAREFULLY TEAR IT OUT, FOLD IT AND DROP IT IN THE MAIL.</i></p> | | SOMETHING WRONG WITH PUBLICATION | |
| | | FROM: (PRINT YOUR UNIT'S COMPLETE ADDRESS) | |
| | | DATE SENT | |
| PUBLICATION NUMBER | | PUBLICATION DATE | PUBLICATION TITLE |
| IN THIS SPACE, TELL WHAT IS WRONG AND WHAT SHOULD BE DONE ABOUT IT. | | | |
| BE EXACT PIN-POINT WHERE IT IS | | | |
| PAGE NO. | PARA-GRAPH | FIGURE NO. | TABLE NO. |
| | | | |
| PRINTED NAME, GRADE OR TITLE AND TELEPHONE NUMBER | | SIGN HERE | |

PIN: 027389-017